

Façade channels

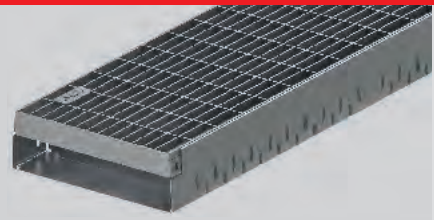

The suitable solution for any task

ACO Profiline

ACO Roofline

ACO Greenline 2.0



ACO. creating the future of drainage



The ACO system chain creates the drainage solutions for the environmental conditions of tomorrow

Increasingly extreme weather events require ever more complex drainage concepts. To this end, ACO creates clever system solutions, which function in both directions: They protect people from water – and vice versa. Each ACO product within the ACO system chain secures the direction of the water with the objective of being able to recover it in a way that makes ecological and economic sense. Within the ACO Group, ACO Building Material supports the global system chain with protective construction elements and drainage systems for modern and sustainable architecture in private and commercial building construction.

2
III



collect:
Collect and carry

- drainage channels and yard gullies
- façade channels
- bath drainage
- floor gullies
- manhole covers



clean:
Pre-clean and treat

- shoe scrapers



hold:
Hold and retain

- basement window
- pressurised water-tight light shafts
- backflow systems



release:
Pump, discharge and reuse

- infiltration trench
- honeycomb mesh grass paver and gravel stabilisation
- lifting Plant



ACO system chain in action

Content

Façade channels	Page
Introduction	04
Profiline – the high-quality system in variable and fixed building height	06
Drainage line for ceramic surfaces	10
Profiline wood terrace channel	12
Profiline wedge-shaped channel	14
Greenline 2.0 – the functional variant with a fixed building height	16
Roofline – the system with free fixable height adjustment	18
Assembly instructions AC0 Roofline	19
Accessories – Gully tops for roof gullies – Extension elements for gully top – Branch channels	20
Cover gratings for gully tops for roof gullies	21
Cover gratings for Profiline, for Roofline	22
ACO reveal frames	24
Further information	
Hydraulics – Testing the Profiline on one of the test benches recognised by the State factory inspectory	26
Barrier-free door sills - low connection heights through façade and terrace channels	30
References	34
Assembly instruction Profiline	36
Product data sheet	42

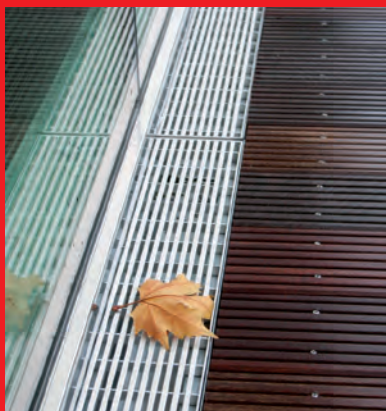

Barrier-free doorstep for balconies, patios and roof top gardens by means of AC0 façade channels

Each AC0 Building Material product supports the AC0 system chain

AC0 façade channels – the suitable solution for any task

Steps must be taken to ensure that no moisture can penetrate the building from the outside, especially in sensitive door and external areas of terraces, roof gardens and balconies at any time. AC0 façade channels guarantee this and discharge even large amounts of rain safely and quickly by means of backflow reserves. Available in stainless steel and galvanised steel versions, the AC0 façade channels go perfectly with all complex architectural building projects. Various design variants can be achieved using the different grating designs. Thanks to the variable height adjustment, millimetre-precise fitting on site soil conditions is possible. This means that AC0 not only facilitates the future-oriented demand for barrier-free construction, but it also meets the quality requirements of architects and planners.

The suitable solution for any task



ACO façade and terrace channels serve to meet the requirements of the regulations and prevent water being pressed upwards as a result of the wind load or collection in front of particularly endangered areas. The creation of snow drifts, slush and ice should also be taken into account here. Snow drifts in front of doors melt first due to the heat radiation in this area. This can impede the drainage of the melted water as a result of the residual snow or slush. As a result, the drainage channels must also be particularly well suited for these kinds of water loads. **The channel height must be adjusted to the actual moisture load. Corresponding hydraulic verification** can be provided by the application technology department at ACO Building Material at any time.

Therefore, important criteria for assessing the efficiency of drainage channels are their location, the size, the opening cross-section of the cover and the channel body, and the installation situation.

A drainage channel will only be able to function **with full effect** when reducing the risk of moisture near a door sill, if it covers the **entire width** and is arranged correctly in front of it. This is usually the case if the distance is not more than **5 cm**. Most of the deposits caused by dirt are retained by the channel body and can be easily removed via the channel base without damaging the sealing ring. Regular maintenance should be a matter of course here.

To drain terraces, the surface water and suspended substances are discharged via the lateral drainage slots into branch channels that lead to the gullies, in the free area below block pavements on raised floors/sacks of mortar and/or into the drainage layer. The drainage slots may not be smaller than 4 mm, otherwise there is a risk of sintering.

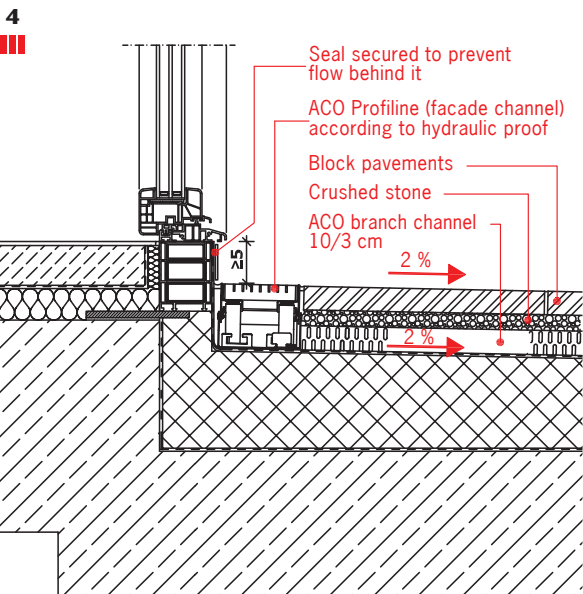

Reduction of the door connection height to 5 cm

Steps must be taken to ensure that no moisture can penetrate the building from the outside, especially in sensitive door and external areas at any time. The 15 cm connection height for building seals specified in the DIN 18531 and the Flat Roof Directive can be reduced to 5 cm by using the ACO linear drainage systems near the door.

Amendment of the Flat Roof Directive 12/2016 if the splashwater volume is not minimised by a roof, mesh gratings that are at least 150 mm wide should be used".

Using gravel that is smaller than 4 mm is non-critical because experience has shown that the chips jam, which means very little gravel penetrates the drainage slot and enters into the channel. If deposits collect on or in the grating through an inserted **dirt fleece**, the entire design must be seen as **critical**. **One-sided perforation** of channel bodies on the façade **does not make sense**, because this is a loosely installed open channel system in which the moisture also forms on the façade side. If there is two-sided perforation of the channel sides, the moisture can be seen as without pressure and fast drying.

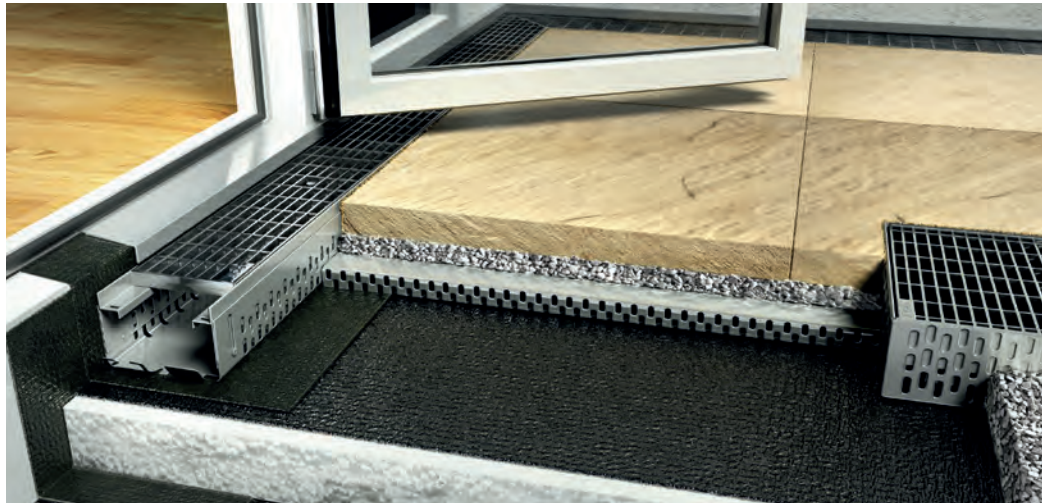

System configuration in front of patio door

Assessment of the actual moisture load

The actual moisture and water load depends on the region where the building project is located, i.e. on the intensity of rainfall and snowfall, and the prevailing wind directions and available protection, e.g. roofs. A corresponding assessment can be provided by the application technology department at ACO Building Material at any time.

The water-carrying layer

The sealing ring and coating level are seen as the water-carrying layers. On reversed roofs, this also includes the insulation level.

The slope

The sealing ring level should have a planned slope of at least 2% falling away from the connecting point. The coating level should have a planned slope of at least 2% falling away from the connecting point. (1.5 % DIN 18531-5)

The ACO branch channel and gully tops for roof gullies

There are accessories comprising a branch channel and variously sized gully tops for roof gullies as maintenance shafts suitable for all channel systems ACO Profiline, ACO Roofline without the branch line connecting element and ACO Greenline. The **branch channel** is a 3 cm high and 10 cm wide hollow body with lateral 4 mm drainage slots. Its

front side is openly joined to the branch channel connection elements and the gully top for roof gullies and/or butt joined to the drainage slots of the channel body and the gully top for roof gullies, and lies within the drainage layer. Therefore, it connects the channel body and the gully top, and forms a defined drainage channel and/or **is a direct connection of the channel to the gully tops**. The gully tops for roof gullies on terrace surfaces must be arranged across the roof gullies as inspection shafts. Mesh gratings that are permanently integrated into the terrace floor may not be permanently connected to the roof gully at the same time.

- 1) Channel or branch channel connecting element,
- 2) Branch channel, 3) Top section with grating, 4) Roof gully

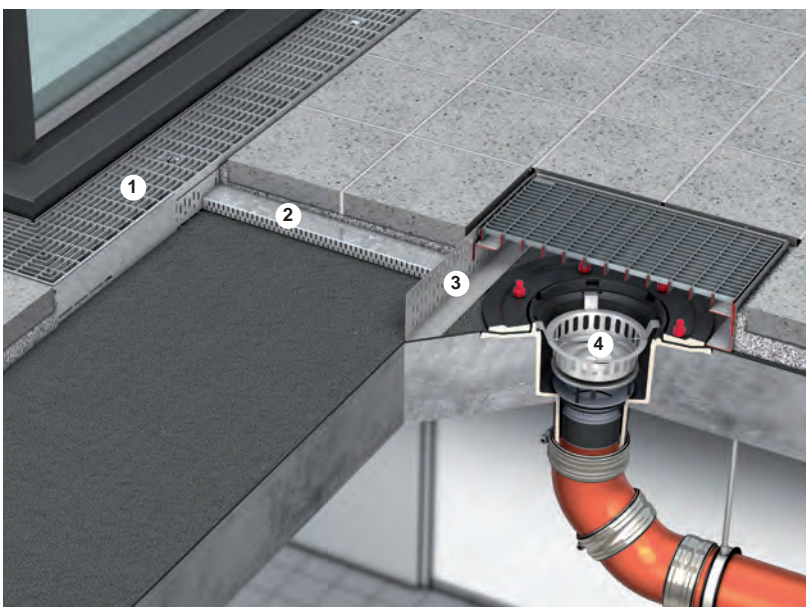

The benefits

- safe and fast drainage of even large volumes of rain
- additional backflow reserve for sudden deluges
- avoidance of water pools near the façade
- protection on the inside from moisture penetrating
- avoidance of splashing water during driving rain
- can be used as a walkable grating during maintenance and servicing

The ACO Profiline system in a variable and fixed building height

Technical perfection down to the finest detail

The pre-mounted channel elements do not have any loose individual components. This means that the channel trains in the modular system can be installed extremely efficiently. The channel elements are connected to one another using a simple plug system with tongue and grooves. This plug system guarantees additional safety when processing on the sensitive sealing ring. The 4 drainage slots are laterally fitted, which reach down to the lower edge to ensure optimum drainage. Thanks to the integrated gravel ledge, no special attachment is necessary. The continuously closed channel base guarantees excellent stability and load distribution. The compensation elements also allows free adjustment of the length of the channel body.

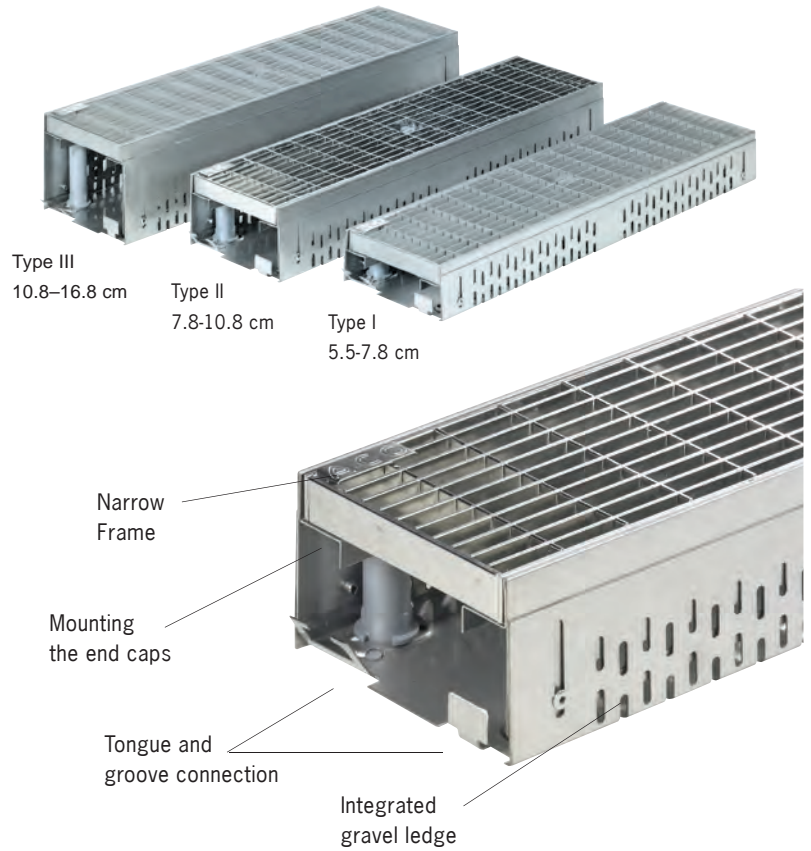

Variable overall building height

The height of the ACO Profiline system with its freely adjustable building height is easily adjusted at the top with a screwdriver, which means it can also be adjusted once it has been installed.

- no precise construction height needs to be defined in the planning phase
- if the overall structure settles, the channel system is simply and easily readjusted
- flexible compensation of longitudinal slope



Height adjustment



Grating stop

Fixed overall building height

The ACO Profiline system with a fixed building height of 2 cm / 3 cm / 5 cm / 7.5 cm and 10 cm not only offers the height adjustment but also all the benefits of an adjustable system.

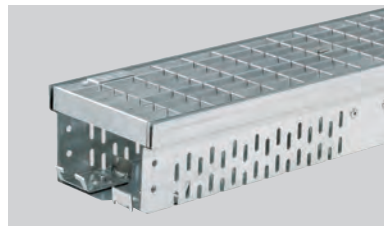

ACO Profiline with a fixed building height

ACO Profiline channel elements in stainless steel and galvanised steel

Version	Building height in cm	Width in cm	Length in cm
Type I height-adjustable	5.5 to 7.8	10/13/15.5/20 ¹⁾ /25 ¹⁾	50/100
Type II height-adjustable	7.8 to 10.8	10/13/15.5/20 ¹⁾ /25 ¹⁾	50/100
Type III height-adjustable	10.8 to 16.8	10/13/15.5/20 ¹⁾ /25 ¹⁾	50/100
Wood terrace channel (page 10/11)	2	13/15.5	50/100/150 ²⁾ /200 ²⁾
Fixed building height	3	13/15.5	50/100/200 ²⁾
Fixed building height	5	10/13/15.5/20 ¹⁾ /25 ¹⁾	50/100/200
Fixed building height	7.5	10/13/15,5/20 ¹⁾	50/100/200
Fixed building height	10	10/15.5/13	50/100/200

¹⁾ Only with mesh grating, ²⁾ only in width 15.5 cm

The Profiline channel elements are available in galvanised steel and in stainless steel with inserted grating.

ACO Profiline extension elements for Type I–III and the fixed building height



ACO Profiline variable corner element

The variable corner element allows any angle up to 90° without time-consuming cutting of the channel body. A connecting piece is placed on the channel element and guarantees excellent stability as a grating support. (Does not fit on the compensation element)

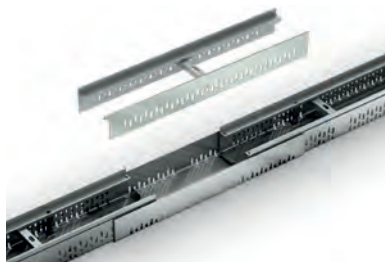

ACO Profiline centre compensation element

The length differences are compensated with the centre compensation element. It is simply placed between two channel bodies and allows free length adjustment of 5 to 50 cm between at least two channel elements.
e.g. 1.35 m: 2 x 0.5 m channel element
1 x centre compensation element

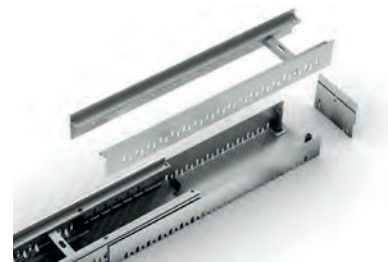

ACO Profiline end compensation element

The end compensation element also allows free length adjustment of 10 to 55 cm behind or in front of a channel element.
e.g. 0.89 m: 1 x 0.5 m channel element
1 x end compensation element

Branch channel connection element

The branch channel connection elements fulfil the requirement for direct and/or indirect connection to a drainage system. The side wall can be opened, the branch channel is inserted over the upright side parts. These affix the branch channel in position during processing.

The elements are each 0.5 m long and can be inserted at the corresponding point in the channel train. The other end of the branch channel ends on the gully top for roof gullies that also needs to be opened.

ACO Profiline end caps

The end caps serve as a variable or fixed element to close the channel body.

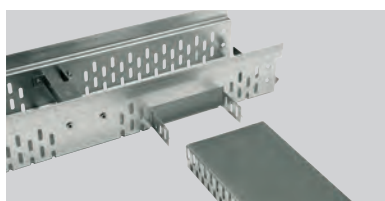
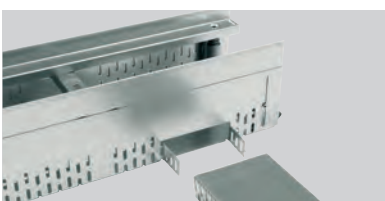

ACO Profiline end cap, fixed building height

ACO Profiline end cap with building height adjustment to overall system

ACO Profiline system overview

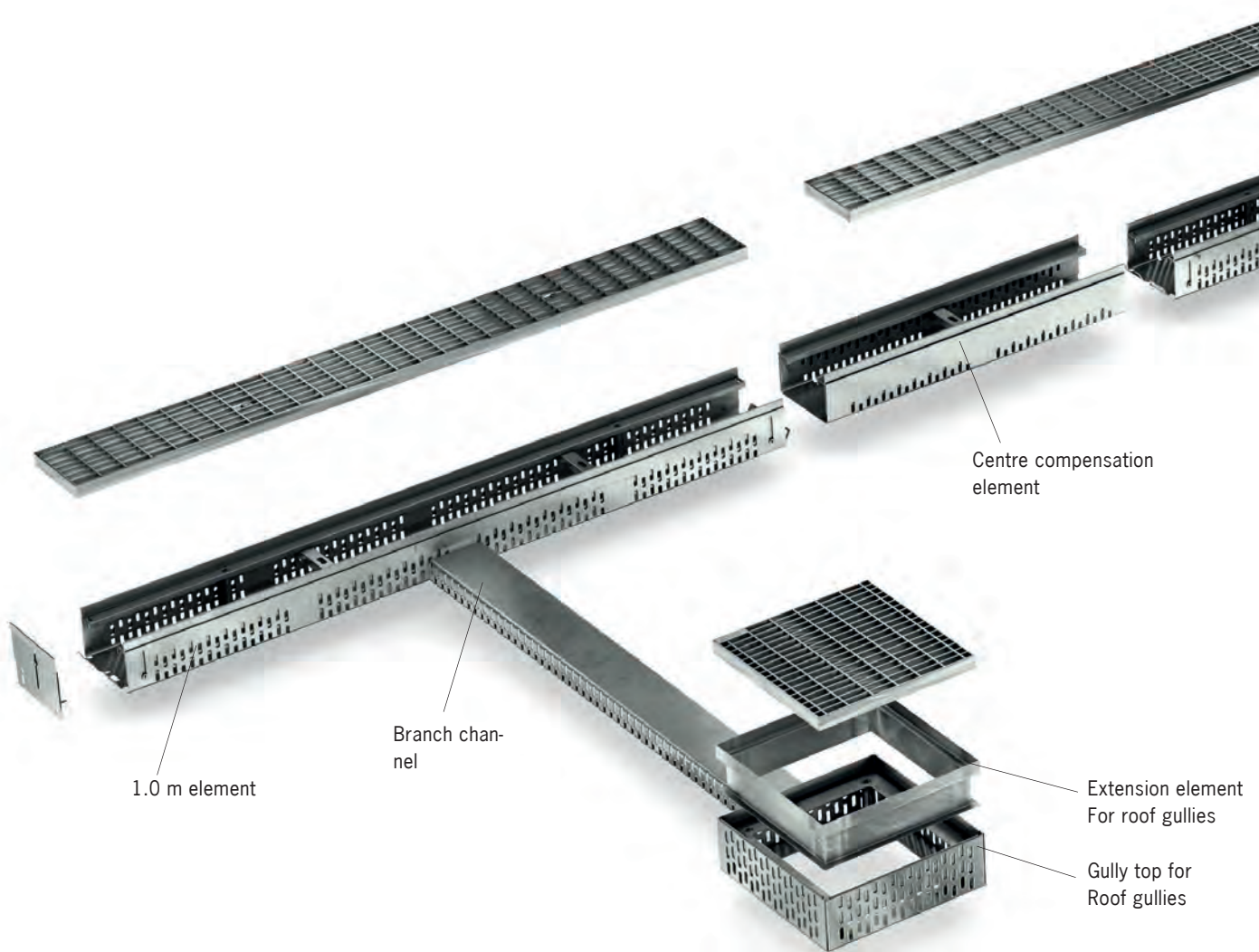

Connection of the branch channel

The branch channel connection elements fulfil the requirement for direct and/or indirect connection to a drainage system. The side wall of the channel body and the gully top can be opened, the branch channel is inserted over the upright side parts. These affix the branch channel in position during processing.

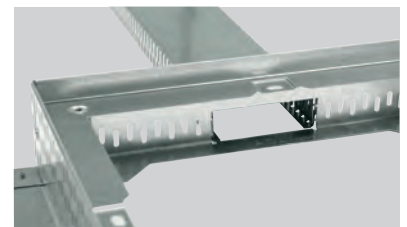
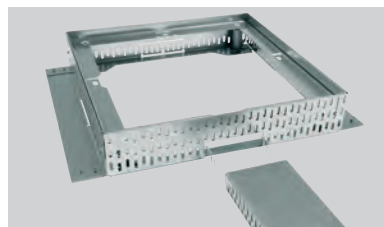
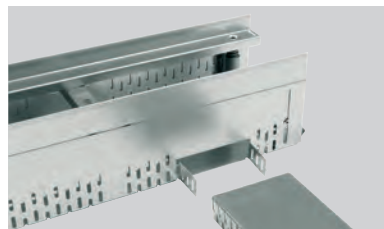

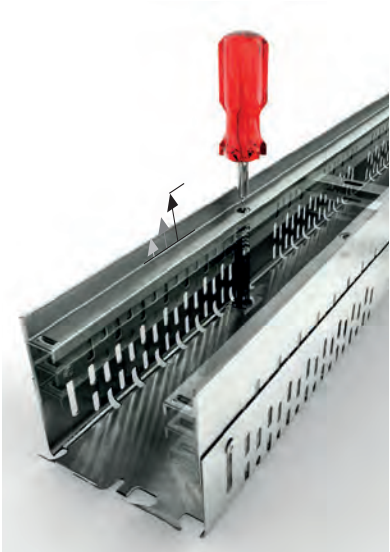
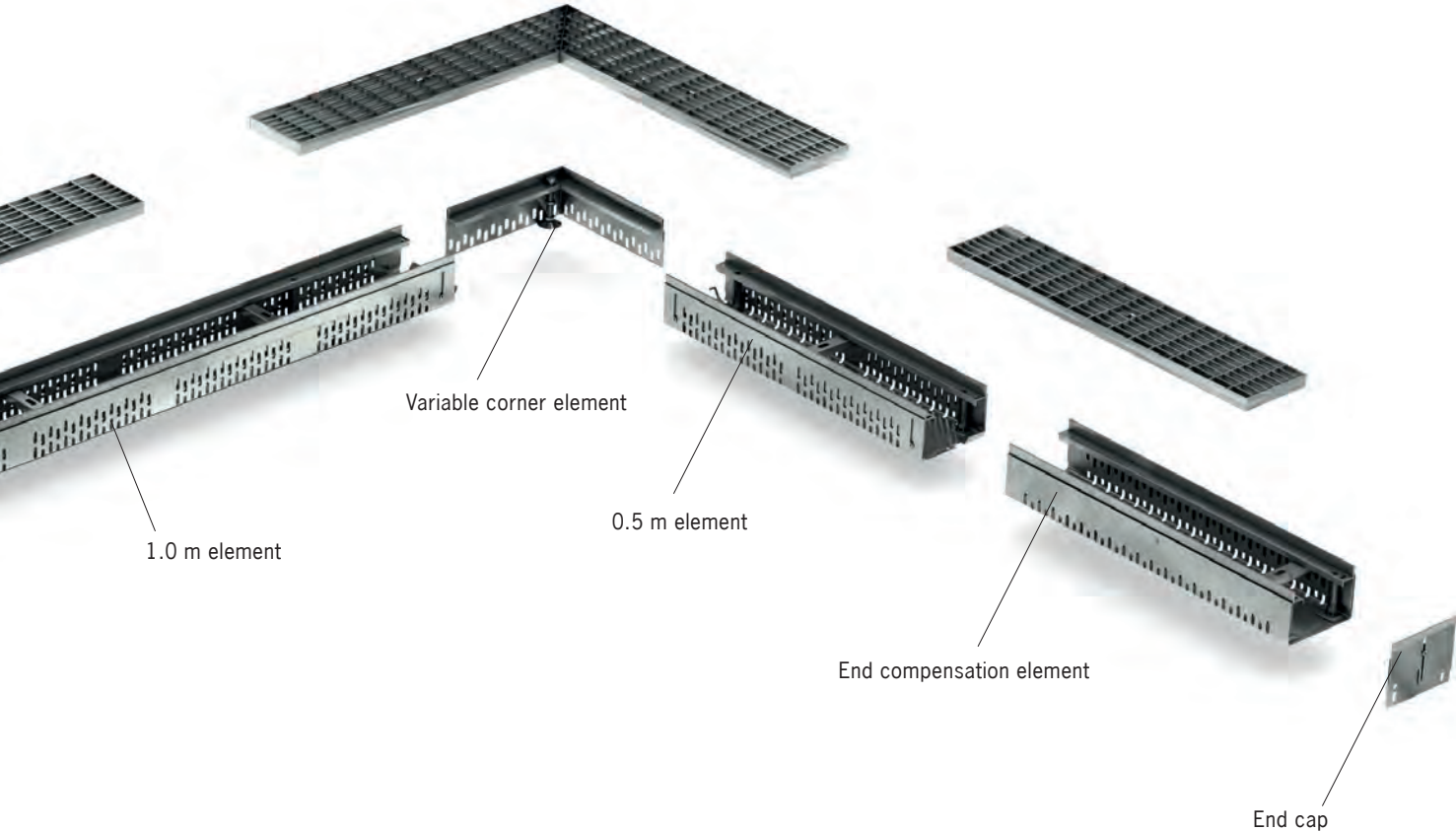

ACO Profiline – height can be adjusted from above



ACO Profiline in combination with a branch channel below the block pavement

Drainage solution for ceramic surfaces in outdoor areas



When using open façade channels in areas that have contact to the earth, also ceramic surfaces, ensure that moisture is directed to the base area. The channels must be connected in any case. To this end ACO supplies two possibilities: one with a direct connection to the bottom via an eccentric **plug-in socket** that goes from a diameter of 60 mm to DN 100, or a **reveal gully element** that can be connected on laterally and protrudes over the foundation or protruding thermal insulation.

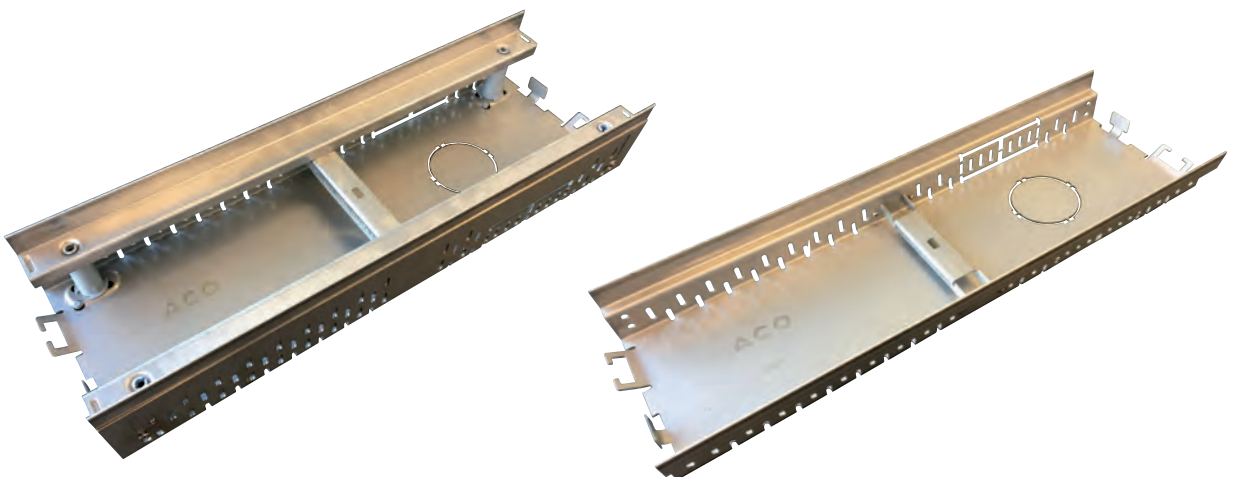

The 0.5 m elements are prepared for all connections accordingly.

ACO Profiline plug-in socket

Eccentric from 60 mm to DN 100

If the façade channel can be directly connected below, there is a plug-in socket \varnothing 60 mm to DN 100 that can be placed eccentrically into the channel base. The connection can be easily positioned by turning it. The dirt trap also prevents coarse dirt entering.

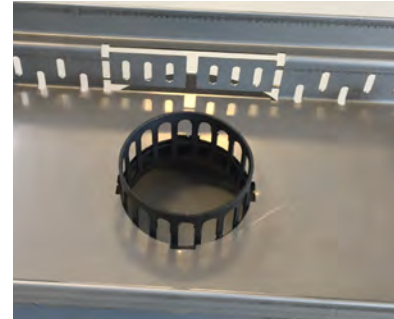
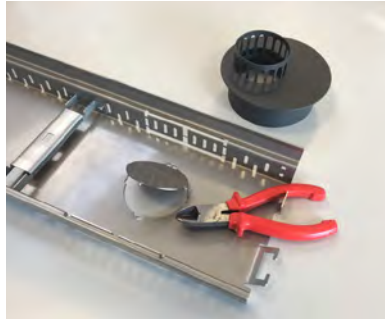

Opening the perforation in the soil and inserting the plug-in socket

ACO Profiline reveal element

Opening the perforation in the side wall and connecting the reveal gully element with an inspection option and connecting to a DN 100 drainage line.

Frequently, only the channel side is available for a direct connection to the drainage in the reveal area. Thanks to the selected design, the reveal gully element can be placed on the branch channel connection and can also be inspected after installation; it can also be connected to a DN 100 pipe system. The reveal gully element supplements the ACO Profiline façade drainage system and is a further variant in addition to the installation of a branch channel.

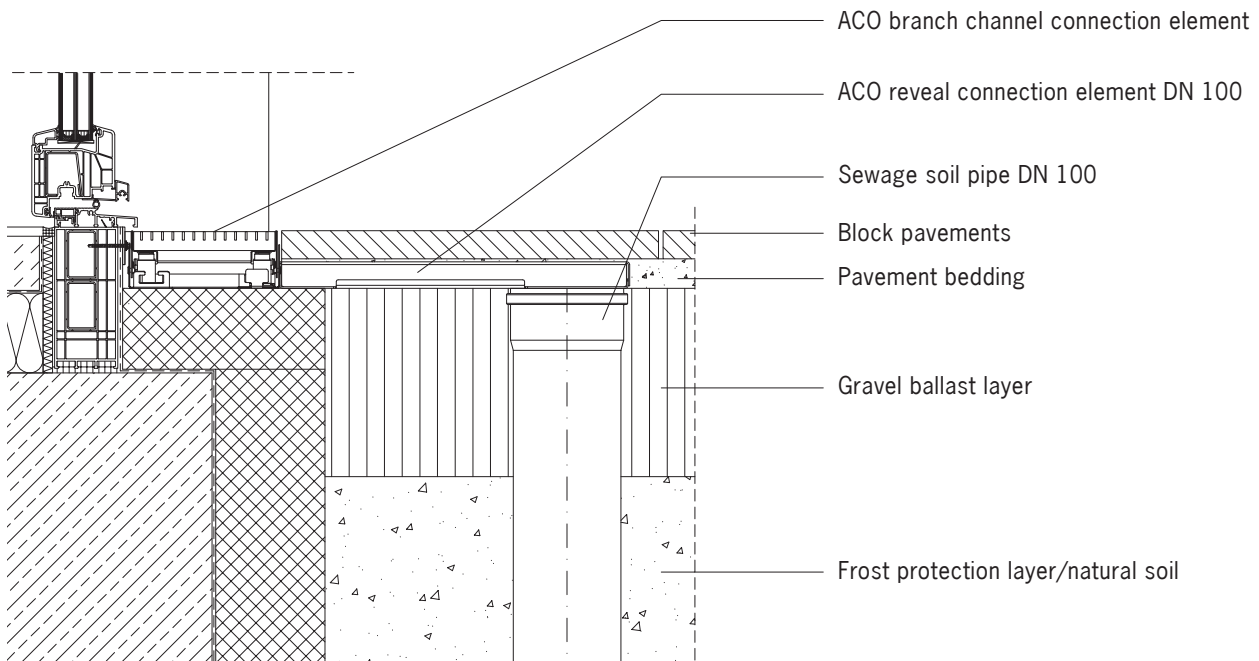
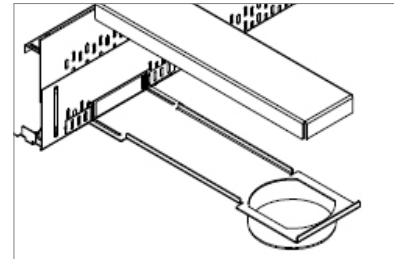

ACO Profiline wood terrace channel

The ACO Profiline wood terrace channel is specially adapted to the specifications of wood terraces. Thanks to its building height of 2 cm, the system fits every plank thickness. The channel train joint lies directly at a distance of 50 cm from the foundation. The max. sleeper distance is 70 cm. The drainage slots are used for attaching near to the sleeper.



ACO Profiline wood terrace channel with/without mesh grating width 30 x 10 mm

The system

Material: Galvanised steel and stainless steel

Overall width: 13, 15.5 cm

Building height: 2 cm

Overall length: 50, 100, 150¹⁾, 200¹⁾ cm

¹⁾ only in width 15.5 cm

Cover grating: Mesh grating 30x10 mm with stop (recommended)

End cap



End cap

Mesh grating 30/10*



* Grating for width 15.5 cm

The following gratings also fit without stop:

Heelsafe (coarse)



Heelguard (fine)



Longitudinal slot grating



Longitudinal bar grating
3 x 15 mm bar*

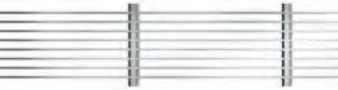

Longitudinal profile grating



Longitudinal*



Use

The transition to the wood terrace is a sensitive area, standing water will lead to damage to the building in the medium term. High risk areas are the entrance areas without an effective porch where low sill designs are used.

The sealing height on the ascending façades is clearly regulated in the listed norms and regulations.

- DIN 18531/DIN 18533
- recommendation for planing, construction and maintenance of the transition areas between open areas and FLL buildings
- flat Roof Directive 12/2016

It says here that the sealing ring for preventing floor moisture and any backlogged seepage water must be installed 30 cm above the top edge of the railing, so that when finally installed, a distance of 15 cm from the top edge of the finished coating to the upper end of the sealing real is not undercut. (Note: A building sealing ring is integrated into the wall construction and is possibly not be visible from the outside).

If the connection height of the sealing ring (15 cm) is undercut, a high-performance drainage system needs to be planned.

Also, a clear reduction of the splashwater volume is specified, which the wood coating alone cannot manage.

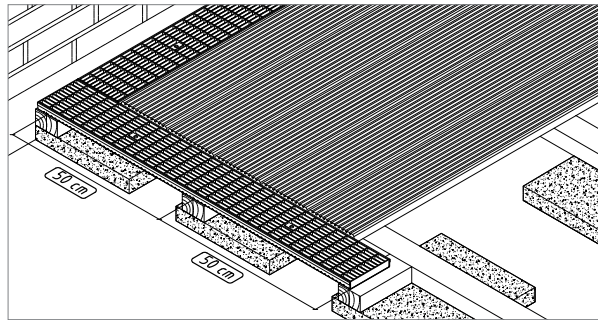
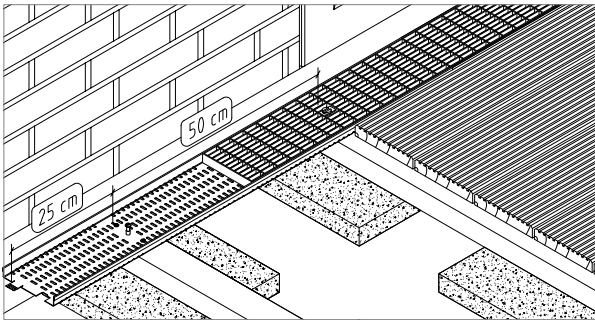
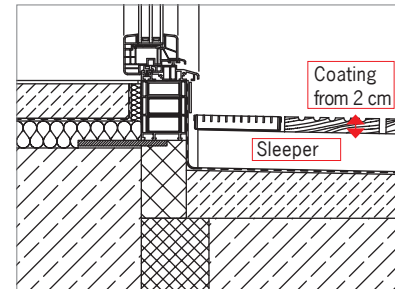

Assembly

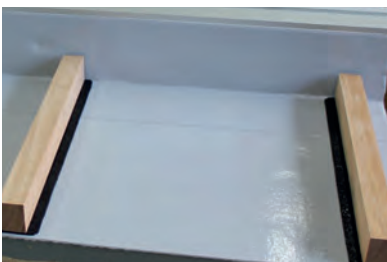

Installation of sleeper onto the sealing ring. Recommended distance for the channel body is 50 cm



Fitting of the wood terrace channel



If necessary, place material below the channel body



The channel body is screwed into the channel base through the 4 mm drainage slot



Check the installation height

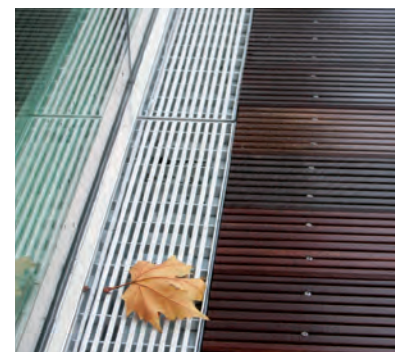

ACO Profiline wedge-shaped channel

The patented ACO Profiline wedge-shaped channel is specially adapted to the specifications of difficult connecting points. With its 5 cm channel body that protrudes on one side, it bridges e.g. any wedges formed by the sealing ring or thermal insulation that lies on the connecting point.

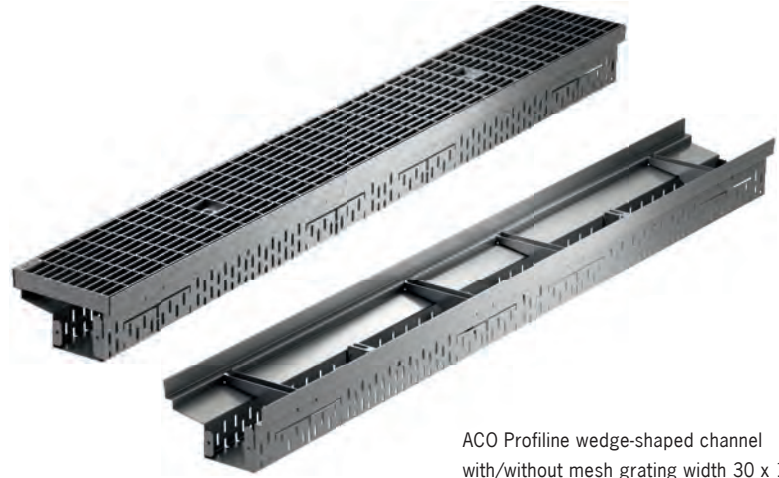

ACO Profiline wedge-shaped channel with/without mesh grating width 30 x 10 mm

The system

Material: Galvanised steel and stainless steel
 Overall width: 13 cm
 Overall building height: 7.5 cm
 Overall length: 50 cm and 100 cm
 Cover grating: all Profiline gratings (except crosswise rod grating)
 End cap



End cap

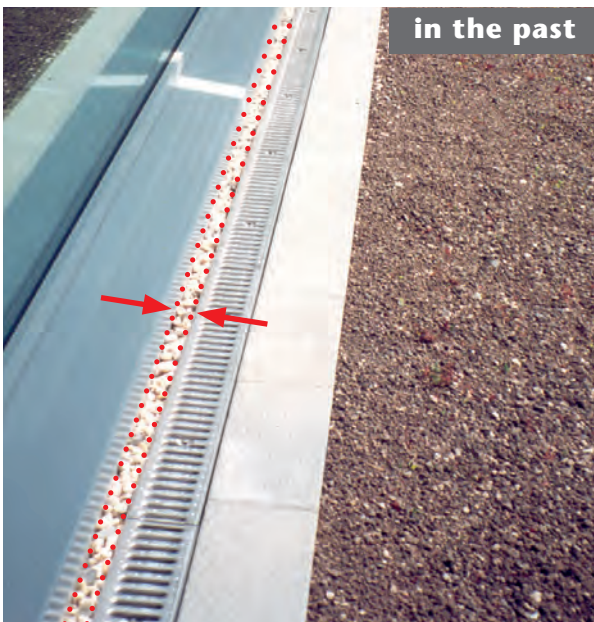

Additional gravel ledge



With the ACO wedge-shaped channel a precise fit in front of façade or door connections without additional gravel ledges

Use

The possibility of inserting the branch channel into the channel body prevents the channel tipping over. This development solves a problem frequently encountered in practice.

The channel can be connected with the coating by opening the side wall and inserting the branch channel so that it does not tilt despite of the slope. Up to 4 branch channels can be used. It is recommended using min. 2 branch channels with a length of 50 cm and a counter-bearing of a e.g. 40 x 40 board. Alternatively, the branch channel can be affixed elsewhere, e.g. By screwing it to the wood foundation.

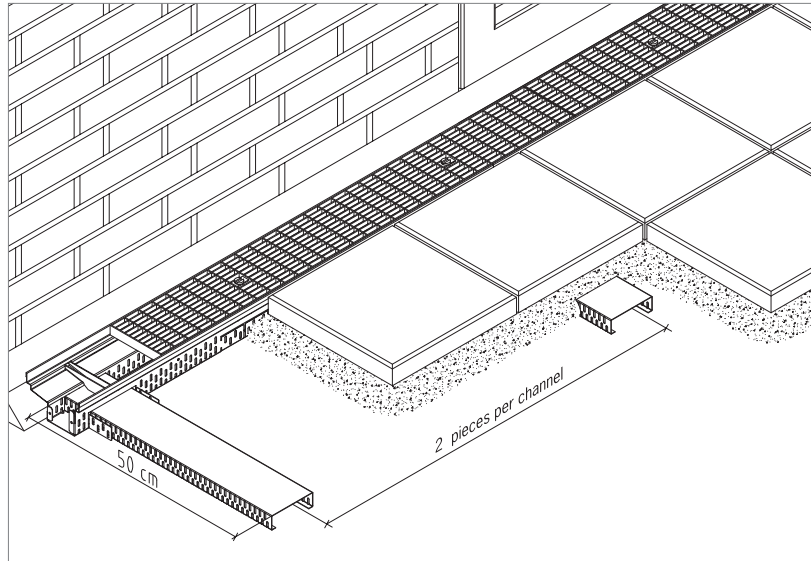

Inserting the branch channel into the channel body means that the block pavement position acts as a counter-bearing so that the channel lies stably despite the wedge

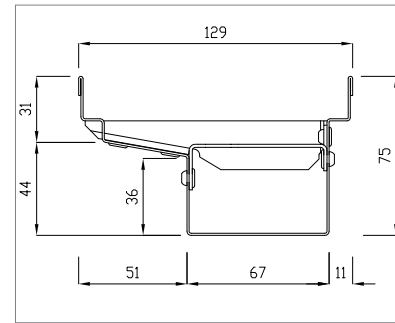
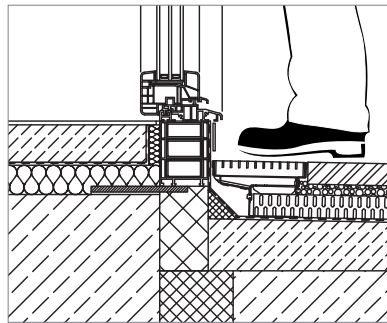

Assembly



Connection of a bitumen-based sealing ring with a wedge



Opening the branch channel connection

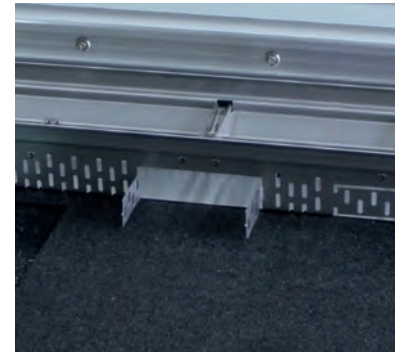

Placement of the channel with the overhand to the connection area



Insertion of the branch channel into the channel. It is recommended using min. 2 branch channels with a length of 50 cm per metre of channel



Inserting the gavel and installation the block pavement

The ACO Greenline 3.0 system – the functional variant with a fixed building height

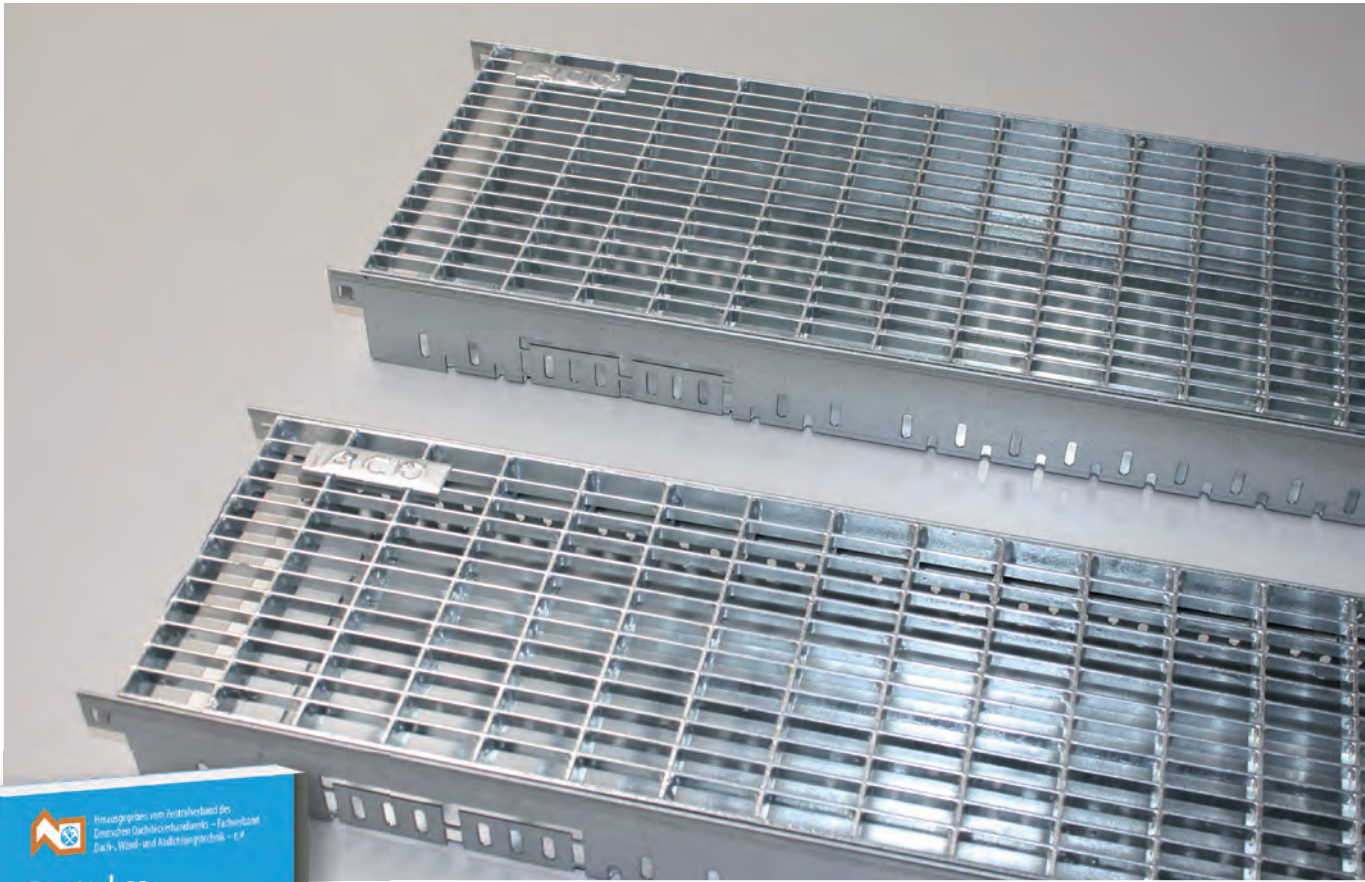

The ACO Greenline 3.0 is a simple but practical façade channel system with everything that is required in the standard. The system replaces the Greenline 2.0. The primary difference is the grating area where inserted gratings are now used. Like all ACO façade channels, the Greenline 3.0 also has a closed channel base to protect the sealing ring. Integrated end caps and channel connection round off the system.

ACO Greenline 3.0 with mesh grating 30/10

- Outer diameter:** 15.5 cm, 20 cm
- Grating width:** 15 cm, 19.5 cm
- building height:** fixed 5 cm
- Overall length:** 200 cm, 100 cm, 50 cm
- Cover:** inserted mesh grating 30/10
- Material:** Galvanised steel
- Load:** are accessible with wheelchairs

- Benefits:**
 - perforation for branch channel or connection element
 - optimised channel connection system
 - integrated end caps, no additional costs for accessories
 - grating slip lock

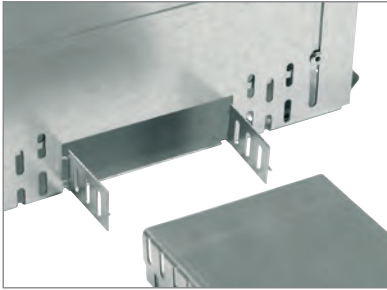

Direct connection

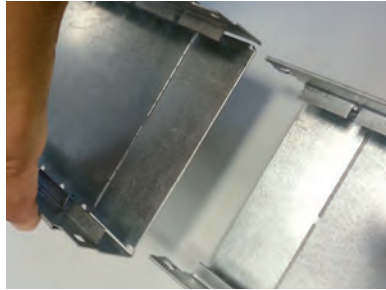

Optimised channel connection

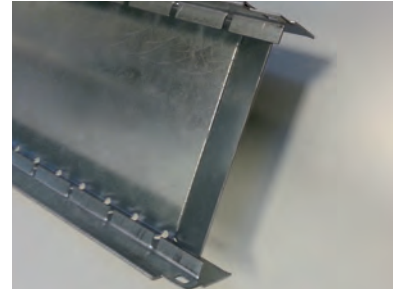

Integrated end cap

- acc. to Flat Roof Directive 12/2016
- minimum grating width 15 cm
- mesh gratings against splashing water
- with direct connection

ACO Greenline 2.0 fixed building height

Description	Dimensions			Article no.
	Length [mm]	Width [mm]	Height [mm]	
Building height 155 mm – Fixed overall height – 50 mm with mesh grating MW 30/10				
Channel element	500	155	50	320323
	1000	155	50	320322
	2000	155	50	320321
Building height 200 mm – Fixed overall height – 50 mm with mesh grating MW 30/10				
Channel element	500	200	50	320326
	1000	200	50	320325
	2000	200	50	320324



The System ACO Roofline with free fixable height adjustment

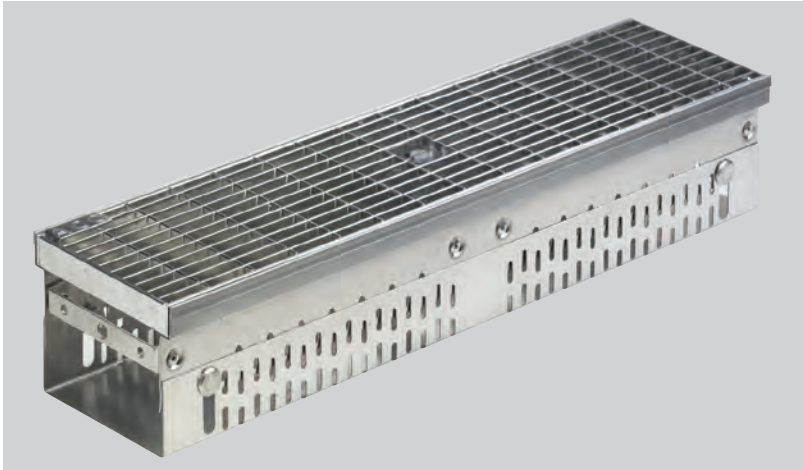

Variable overall building height

The System ACO Roofline with variable building height offers all the benefits of an adjustable system:

- previously integrated gravel ledge
- continuous close channel base
- version in galvanised steel
- inserted lockable cover gratings
- without branch channel connection element



Height adjustment



Grating stop

The height is adjusted from the inside laterally using a wrench SW 13.

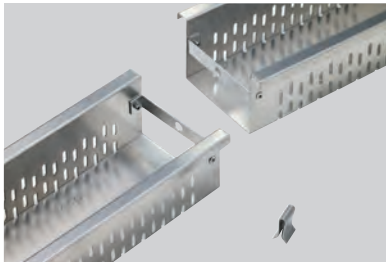

ACO channel connector



The channel elements are simply clipped together with screwless ACO channel connectors.

ACO Roofline channel elements in galvanised steel

Version	Building height in cm	Width in cm	Length in cm
Type I height-adjustable	5.5 to 7.0	13/15.5	50/100
Type II height-adjustable	7.0 to 10.0	13/15.5	50/100
Type III height-adjustable	10.0 to 16.0	13/15.5	50/100

All over grating variants of the Profiline are also available for the Roofline.

Assembly instructions – ACO Roofline

1. Connection of the channel elements



- Picture 1: The channel elements are placed in a row and affixed with the channel connector

2. Attachment of end caps



- Picture 1–2: The end cap is attached with the two pins into the front-side



- boreholes of the channel element

3. The height adjustment



- Picture 1–2: By loosening the lock screw SW 13 mm, the height can be freely adjusted and affixed.

4. The grating stop



- Picture 3: The grating lock is simply activated by turning it a quarter turn to the right or left using a slit screwdriver.

Accessories for all systems

Roof gullies are available from
ACO Building Drainage
www.aco-haustechnik.de

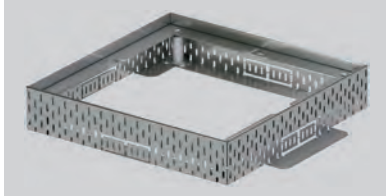

Gully top for roof gullies (height-adjustable)

Gully tops for roof gullies

According to the Flat Roof Directive, removable mesh gratings are arranged over roof gullies on terraces. The gully top for roof gullies from ACO guarantee free access to these gullies and need to be freely adjusted to the height of the overall structure. The gully tops are

available as height-adjustable variants of Type I 5.5 – 7.8 cm and Type II 7.8 – 10.8 cm and in a fixed building height of 5 cm. All gully tops allow the possibility of raising the gully top by means of so-called extension elements in 3, 6 and 12 cm. Here, too, the mesh grating can also be locked.

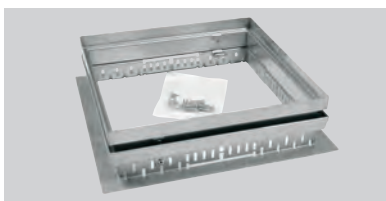

Gully top for roof gullies (fixed height) and extension element

Outer dimensions in cm	Free cross-section in cm	Building height in cm
30 x 30	27.3 x 27.3	5.0
30 x 30	20.0 x 29.3	5.5 to 10.8
40 x 40	37.3 x 37.3	5.0
40 x 40	30.0 x 39.3	5.5 to 10.8
50 x 50	47.3 x 47.3	5.0
50 x 50	40.0 x 49.3	5.5 x 10.8

Available in a stainless steel and galvanised steel version



Extension element for gully top

Extension elements for gully top

The extension element is available in three different dimensions and building heights and can therefore be adapted to any building height thanks to the height adjustment feature. Several extension elements can be used on top of one another to cover greater height differences. A cover grating can be inserted easily.

Dimensions in cm	Building height in cm
30 x 30	3/6/12
40 x 40	3/6/12
50 x 50	3/6/12

Available in a stainless steel and galvanised steel version

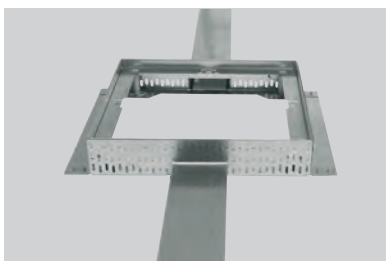

Branch channel

Branch channel connection on the gully top for roof gullies

The branch channel connection elements fulfil the requirement for direct and/or indirect connection to a drainage system. The branch channel can be connected on all 4 sides, which means it can also be used as a maintenance and cleaning shaft.

If used as a cleaning shaft, we recommend installation approx. every 4 m. Actual rinsing can be carried out with a simple garden hose.

Branch channels

The branch channel is placed loosely on the gully top for roof gullies and is fixed in the gravel bed by the overall system. It guarantees the free cross section between the channel body and the gully top for roof gullies.

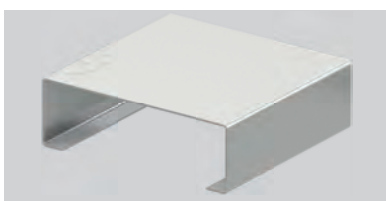

Branch channel connector

Branch channel connector

- length 10 cm
- width 10.4 cm
- height 3.4 cm
- material stainless steel or galvanised steel

- length 100 cm / 200 cm
- width 10 cm
- building Height 3 cm
- material stainless steel or galvanised steel

ACO gully top for roof gullies

All cover gratings in the dimensions 30 x 30 cm, 40 x 40 cm and 50 x 50 cm

Mesh gratings

Mesh grating, galvanised steel or
Stainless steel
with mesh width 30 x 10 mm
Inserted, non-locked grating

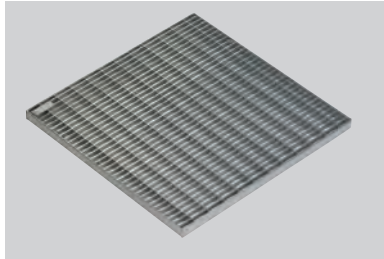

Mesh grating, stainless steel or galvanised steel.

Perforated grating

Pickled stainless steel
Inserted, non-locked grating

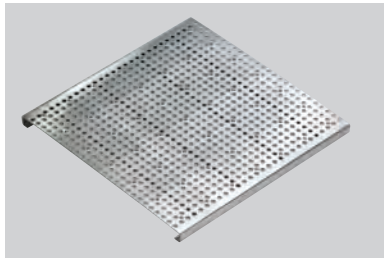

Perforated grating, stainless steel

Heelsafe/Heelguard

Stainless steel
Inserted, non-locked grating

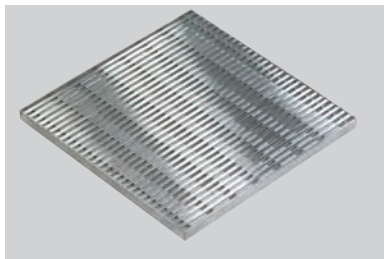

Heelsafe, stainless steel

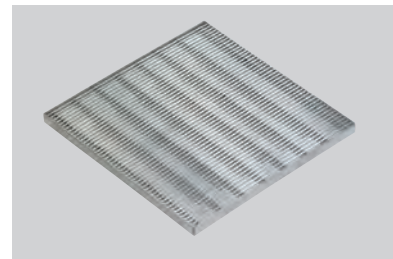

Heelguard, stainless steel

Grating lock for gully top/extension elements for rood gully

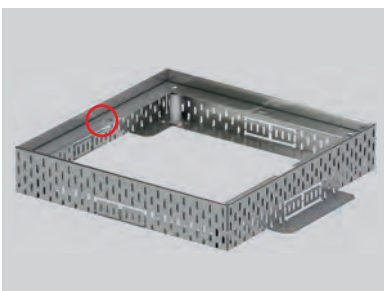

Only mesh gratings can be locked in the gully tops and extension elements. It is also possible to retrofit the locking device for gully tops for roof gullies (caution: System change 05/2016).

Cover gratings for ACO Profiline and ACO Roofline systems

All cover gratings in length 50 cm* and 100 cm

Ladder grating

Galvanised steel

Overall width: 13 cm

Pickled stainless steel

Overall width: 13 cm

Inserted, locked grating



Ladder grating, material stainless steel or galvanised steel

Mesh gratings

Galvanised steel

with mesh width 30 x 10 mm

Overall width: 10/13/15.5/20/25 cm

Stainless steel

with mesh width 30 x 10 mm

Overall width: 10/13/15.5/20/25 cm

Inserted, locked grating

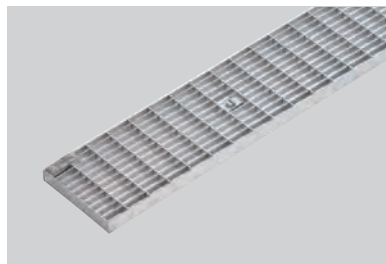

Mesh grating, stainless steel or galvanised steel

Perforated grating

Galvanised steel

Overall width: 10/13 cm

Stainless steel

Overall width: 10/13 cm

Inserted, locked grating



Perforated grating, stainless steel or galvanised steel

Longitudinal rod grating

Galvanised steel

width: 13 cm/15.5 cm

Stainless steel

width: 13 cm/15.5 cm

Inserted grating, without stop

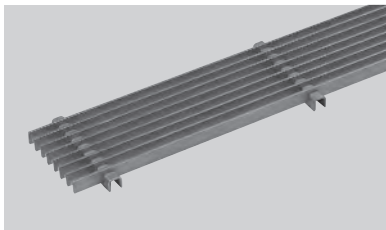

Longitudinal slot grating

Stainless steel

Overall width: 13 cm

Inserted, non-locked grating



Plastic ladder grating

PE-HD recyclable

Overall width: 13 cm

Inserted, non-locked grating



Lengthwise ladder grating

Brushed stainless steel

Overall width: 13 cm/15.5 cm

Inserted grating, without stop



Longitudinal profile grating

Galvanised steel

Overall width: 13 cm

Pickled stainless steel

Overall width: 13 cm

Inserted grating, without stop



* Plastic ladder grating only available in 100 cm length

Cover gratings for ACO Profiline and ACO Roofline systems

All cover gratings in length 50 cm* and 100 cm

ACO Heelsafe (coarse)

Stainless steel

Overall width: 10/13 cm

Inserted, non-locked grating

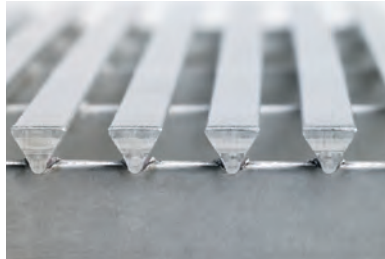

Detail overview of the design

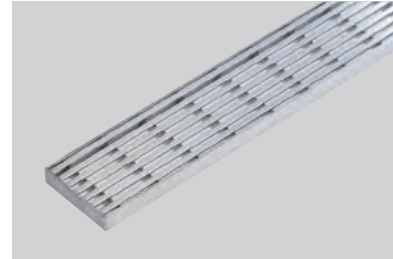

Heelsafe, stainless steel

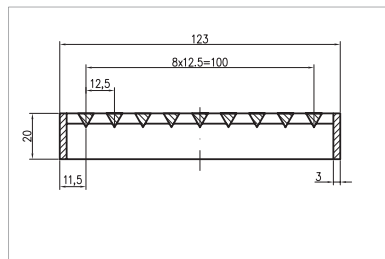

Heelsafe cross-section, 3-edge rod

ACO Heelguard (fine)

Stainless steel

Overall width: 10/13 cm

Inserted, non-locked grating

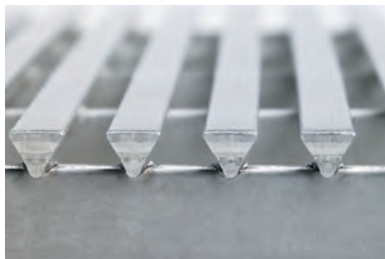

Detail overview of the design

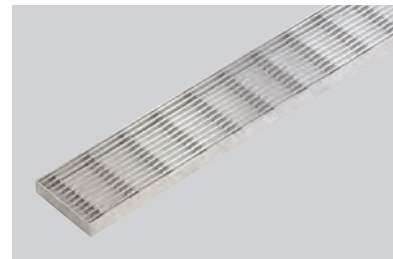

Heelguard, stainless steel

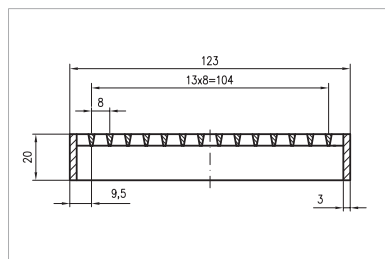

Heelguard cross-section, 3-edge rod

Crosswise rod grating

Galvanised steel

Overall width: 13 cm

Stainless steel

Overall width: 13 cm

Inserted, non-locked grating

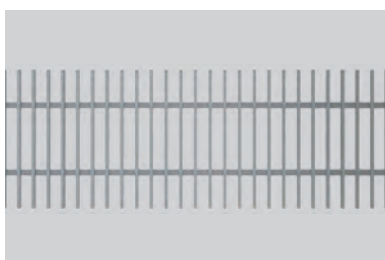

Crosswise bar grating, stainless steel

* Plastic ladder grating only available in 100 cm length

ACO reveal frame – closed façade and terrace channel in the ground

Drainage channels should always be positioned as closely as possible to upright components and/or profiles to collect the water on façades and door/window elements. Also, drainage channels need to be selected according to size, opening diameter of the cover and the channel body so they fit the respective situation.

ACO Building Material now has a new solution, the ACO reveal frame, so that these requirements in the reveal area can be fulfilled. The reveal frames are available in galvanised steel or stainless steel in lengths of up to 2.5 m and heights of at least 5 cm and/or maximum 20 cm. The closed, single unit customised design has a outlet socket DN 50 with a welded-in socket for connection of the drainage line. Cover gratings as mesh gratings and longitudinal rod gratings round off the new drainage system that is a custom-made version to meet on-site specifications.

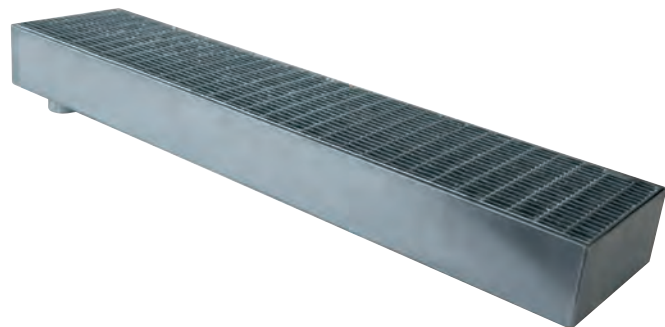

System diagram of insulated cellars

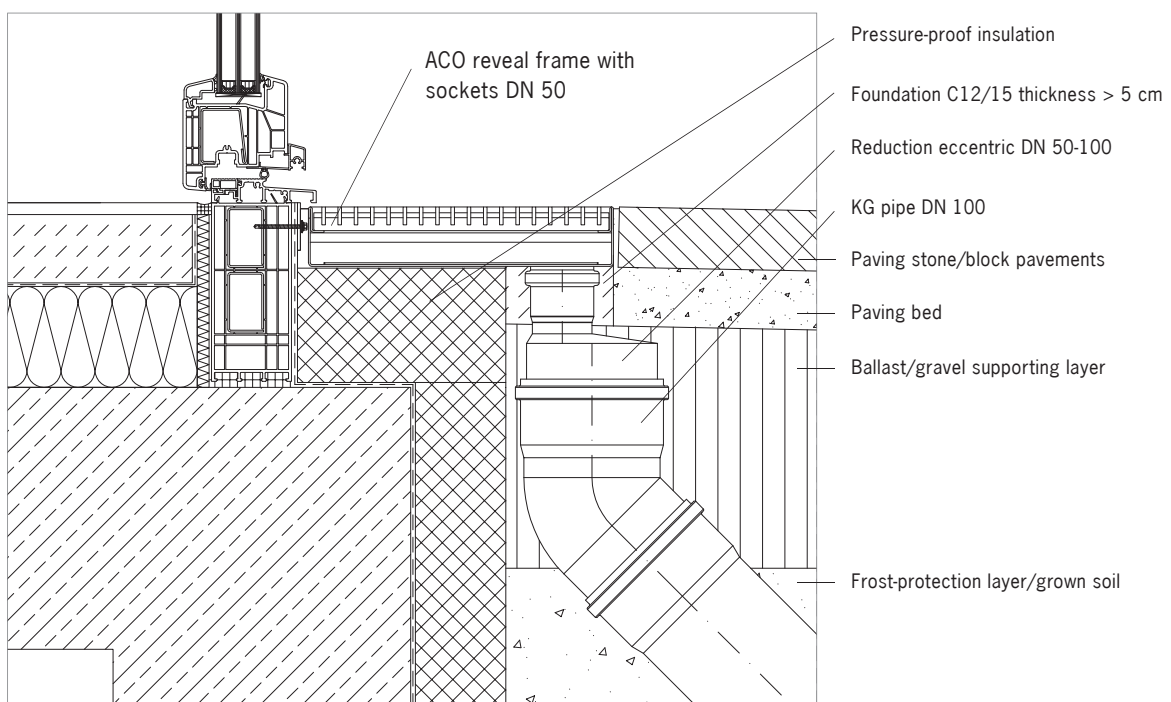



In the reveal area at the base of the building there are often difficulties trying to meet the sealing requirements according to DIN 18533 and the barrier-free requirements of the DIN 18040.

Also, design aspects of the building often make it difficult to use standard drainage channels.

For this reason ACO has included a custom-made version of the reveal frames for local specifications in its façade channel program.

Please ask us about your customised channel system.

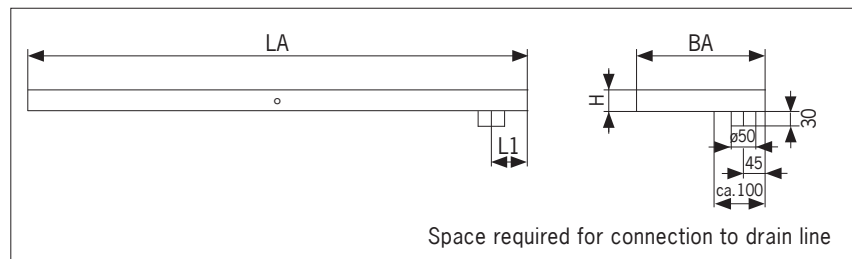
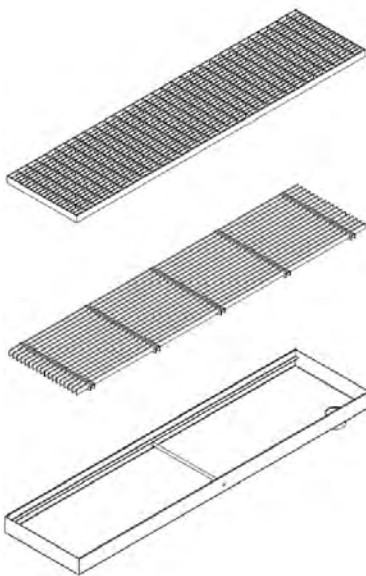

Space required for connection to drain line

Key technical data

Material:
2.0 mm galvanised steel
1.5 mm V2A (1.4301) or V4A (1.4401)

Dimensions:
Outer length LA: 50 cm – 235 cm
Outer width BA: 20 cm – 50 cm
Height H: 5 cm – 20 cm

ACO mesh grating 30/10mm*
ACO longitudinal bar grating 3x15 mm*

*Cover gratings longer than 1 m in length come in several parts

Channel body

Closed, single unit channel with outlet socket DN 50 with welded-in round rod for reinforcement

Material: Galvanised Steel , V2A (1.4301), V4A (1.4401)

Cover gratings:

ACO mesh grating 30/10 mm, accessible on foot, accessible with wheelchair, no locking device
Material: Galvanised Steel , V2A (1.4301), V4A (1.4401)

ACO ProfilLine longitudinal bar grating 3 x 15 mm
accessible on foot, accessible with wheel chair, no locking device
Material: Galvanised Steel , V2A (1.4301), V4A (1.4401)

Hydraulic test of the ACO Profiline system

The hydraulic performance of the ACO Profiline channel system has been tested on one of the independently monitored test benches recognised by the State factory inspectory.

Goals:

- gaining further practical insights about the performance of various ACO Profiline types and their covers
- verification of the hydraulic calculation principles
- assessment of the drainage performance for various roof structures
- ensuring the assessment of barrier-free transition elements

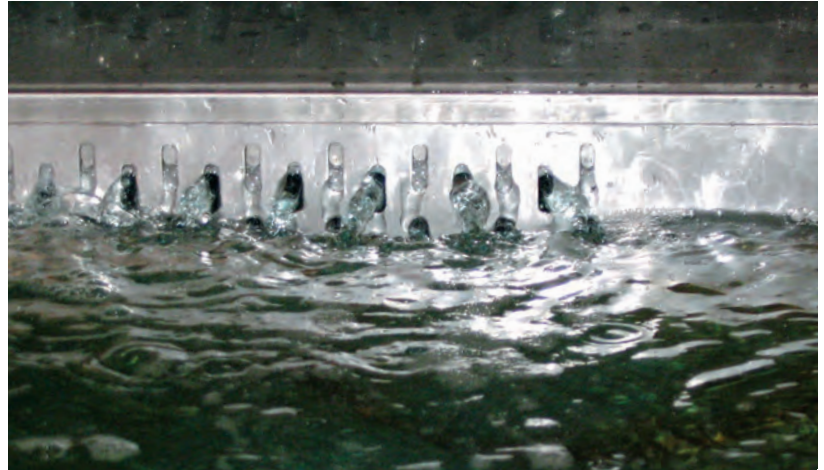

Test bench

- test report no. 5351022-20 (State factory inspectory-certification)
- test pool 2 m x 2 m x 0.8 m
- test pool volume approx. 2,500 l
- pump performance 40 l/s
- rated connection widths DN 40 – DN 150
- testing flat roof gullies, façade channels etc.
- testing seals up to 0.5 bar
- train length respectively 1 m



Test set-up

The hydraulic performance of the ACO façade channels is primarily influenced by the installation situation and the cover gratings. The example calculations clearly show the huge impact of the underlying conditions. Especially in the field of barrier-free door sills it's clear

that free water flow is the decisive factor.

There will be no general solution for each barrier-free door sill in the future, however we can provide support in the planning phase.



Testing the channel body with mesh grating 30 x 10 mm, free gully with raised coating

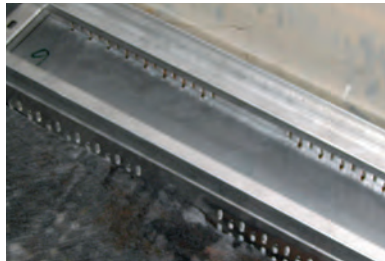

Test set-up with drainage mat and gravel bed in front of the channel body



Test set-up with drainage mat and gravel bed in front of the gully top

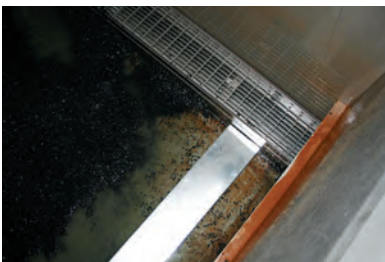

Test set-up with branch channel lateral (without a section in the channel body)



Test set-up with branch channel lateral (without a section in the gully top for roof gullies)



Gravel bed with 2/5 mm gravel



Channel system loosely installed

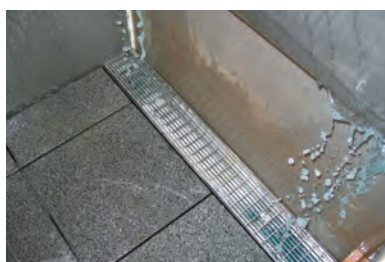

Rainfall on the installed façade channel



Water level up to the lower edge of the cover grating



Maximum rainfall of the surface clearly shows the important function of the gully tops for roof gullies



When clean, an inserted dirt fleece reduces the hydraulic performance of the system by 30%



Results of the hydraulic test of the ACO Profiline system

	Overall width 10 cm l/(sec x m)	Overall width 13/15.5 cm l/(sec x m)	Overall width 20/25 cm l/(sec x m)	Remarks
Fixed building height 5.0 cm Mesh grating 30/10	1.15	1.15	1.15	No spraying
Fixed building height 7.5 cm Mesh grating 30/10	2.50	2.50	2.50	No spraying
Type I – adjustable 5.5 – 7.8 mm Mesh grating 30/10	1.50 to 2.25	1.50 to 2.50	1.50 to 2.50	No spraying
Type II – adjustable 7.8 – 10.8 mm Mesh grating 30/10	2.25 to 3.40	2.50 to 3.75	2.50 to 3.75	No spraying
Type III adjustable 10.8 bis 16.8 cm mesh grating 30/10	3.40 to 4.15	3.75 to 5.25	3.25 to 5.25	No spraying
Ladder grating	–	2.25	–	Light spraying
Perforated grating	–	0.75	–	Heavy spraying
Heelsafe 7/12.5	–	2.50	–	Light spraying
Heelguard 3/8	–	2.50	–	Light spraying
Longitudinal slot grating	–	0.75	–	Heavy spraying
Crosswise slot grating	–	0.75	–	Heavy spraying
Mesh 30/10 with dirt fleece 135 g/m ²		Reduction -30%		Not recommended (risk of blockages)
Boards (4 cm) on raised floor sup- ports construction height 9 cm		Drainage output see above		Recommendation barri- er-free transition elements
Boards (4 cm) in double-crushed chips (2/5 mm), with branch channel to the gullies, construction height 9 cm		0.50		Drainage via gravel bed and branch channel
Boards (4 cm) in double-crushed chips (2/5 mm), with drainage mat (1 cm), construction height 9 cm		0.50		Drainage via gravel bed and drainage mat
Boards (4 cm) in double-crushed chips (2/5 mm), construction height 9 cm		0.20		Drainage via gravel bed

The test was carried out respectively on a train length of 1 m

Excerpts from the basis for calculating the rainfall

Rainfall calculations

- Rainfall acc. to DIN EN 12056
0.03 l/(sec x m²) acc. to 300 l/(sec x ha)
- Rainfall acc. to DIN 1986-100:2008-05
0,0452 l/(sec x m²) acc. to 452 l/(sec x ha)
(r 5.5 for Rosenheim — so-called 5-minute rain)
- Rainfall acc. to DIN 1986-100:2008-05
0,0853 l/(sec x m²) acc. to 853 l/(sec x ha)
(r 5,100 for Rosenheim — so-called century rain)

Calculation for façade channels with supported coating

- ACO Profiline fixed building height 7.5 cm with mesh 30 x 10 = 2.50 l/(sec x m)
- Rainfall 0.03 l/(sec x m²) (acc. to DIN 12056)
- Block pavements on floor supports (free gully)
- The façade is calculated with 50% of the surface

Example calculation for the maximum drainage output

- Hydraulic performance of the channel: Rainfall x 50% figure for façade

$$\frac{2,50 \text{ l}}{\text{s} \times \text{m}} : \frac{0,03 \text{ l}}{\text{s} \times \text{m}^2} \times 2$$

Result: 166.5 m façade height per metre channel train

Calculation for façade channels with coating in gravel bed

- ACO Profiline fixed building height 7.5 cm with mesh 30 x 10 = 2.50 l/(sec x m)
- Rainfall 0.0853 l/(sec x m²) (acc. to DIN 1986-100 for Rosenheim)
- Block pavements in the 2/5 gravel bed 0.20 l/(sec x m)
- The façade is calculated with 50% of the surface

Example calculation for the minimum drainage output

- Hydraulic performance of the gravel bed : Rainfall x 50% figure for façade

$$\frac{2,50 \text{ l}}{\text{s} \times \text{m}} : \frac{0,0853 \text{ l}}{\text{s} \times \text{m}^2} \times 2$$

Result: 4.69 m façade height per metre channel train

Comfort has no age preference

Product certificates cannot replace the following three most important requirements for the successful installation of barrier-free door sills:

- consulting in the planning phase
- calculation of the drainage output
- practical experiences

ACO will help you with all these issues.



Entrance doors without sills are always used in public buildings

Transitions that are as level as possible between residential areas and roof terraces, the balcony or porch and the stepless building entrance areas are critical design points that need to be planned with care because the effect of the weather (driving rain, snow drifts) can quickly cause damage to the building. All underlying conditions, e.g. structure thickness inside and outside, ceiling offset and slope need to be taken into account as early as the planning phase.



Sill-free transition between buildings and outdoors

often leads to conflicts with technical directives. There are proven solutions for this, however they do not always comply with all guidelines: Installing outer drain channels parallel to the door can help to protect against moisture without creating an excessive height difference between the outside and the inside level.

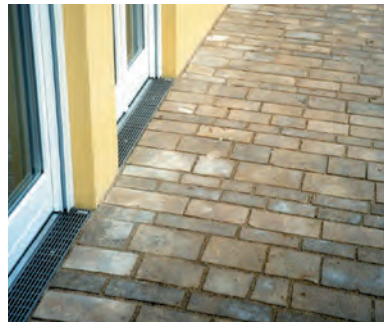

The specifications of the directives

are not only inconsistent to the formulated specifications for barrier-free construction, but were and are seen as impractical by numerous architects, facility management and residents alike. Large sill heights are undesirable in many areas and are not installed.



Barrier-free door sill – checklist for planning

Planning barrier-free door sills

All experience with reducing the connecting height from 15 cm to 5 cm should be used.

The following points should be taken into account when planning barrier-free door sills:

- planned height of the raw construction
- structure thicknesses inside and outside
- thermal insulation
- slope version

General sill design

- it is a special design that needs to be specified by the planning department
- drainage channel is mandatory in this area
- the building owner must approve this connection detail
- the planner and the builder must coordinate this

Assessment of the planned sill design

- hydraulic calculations of a drainage channel must be available
- a roof, a closed railing or lateral weather protection can help
- check and ensure the alignment and main wind direction

Assessment of the surface drainage

- we recommend a raised surface coating with at least 3 cm space to the horizontal drainage
- support for the gravel or stone layer by means of drainage mats or branch channels leads to significant improvements here
- drainage layers only comprising stones or gravel have the lowest drainage effect and also the most unreliable due to pollution

Slope

- a planned slope of at least 2% of all water-carrying layers (1.5 % DIN 18531-5)
- slope must always face away from the connection point.

Sealing ring

- the sealing ring should reach up to at least the top edge of the channel system
- the sealing ring must be secured against back-seepage
- on-site storage of the sealing ring

Roof gullies

- at least two drainage points are required
- an emergency overflow can also be used as a second drainage point

Drainage channel

- dimensioning should be according to the hydrolic calculation, taking into account all of the underlying conditions.
- installation across the entire lateral width to the running direction
- maximum clearance to the sealing ring connection 5 cm
- use of channel bodies with perforation on both sides

Cover gratings

- use of mesh gratings (mesh 30 x 10, the longer mesh width lateral to the running direction)
- more than 50% free opening diameter
- minimum slot width of 8 mm
- we do not advise using a dirt fleece below the grating. The system stops being functional when the mesh is obstructed

Lower door hinges and door sills barrier-free

- the tightness of the lower door hinges can be achieved by using special door systems
- the sealing ring must be secured against back-seepage of the door profile
- the sealing ring and the door profile should reach up to at least the top edge of the channel system
- maximum height 2 cm

Summary

Correctly dimensioning the ACO façade and terrace channel in the pre-planning phase restores the lost connection height of the sealing ring.

A barrier-free door sill also needs to be on the same level after taking into account all listed underlying conditions.

Bibliography

Important contents were drafted in collaboration with and the kind permission of the author engineer Nils Oster, Ö.B.U.V. Authority, and are contained in the book 'Damage to balconies' from the series 'Damage-free construction' by the Fraunhofer IRB publishing house.

Building sealing ring – summary of DIN norms and special regulations

Max. 15 cm connection height of sealing rings on doors, glass fronts and similar to the surface of the coating with additional measures is possible.

- rules for roofs with sealing ring (Flat Roof Directive), Par. 4.4 (1) connection height on doors, fig. 6.1 (As per: 12/2016)
- DIN 18531-5 Sealing rings on roofs, balconies, porches and access balconies

Balcony with roof gully 'Sealing height' according to standard Roof edge with wall flange

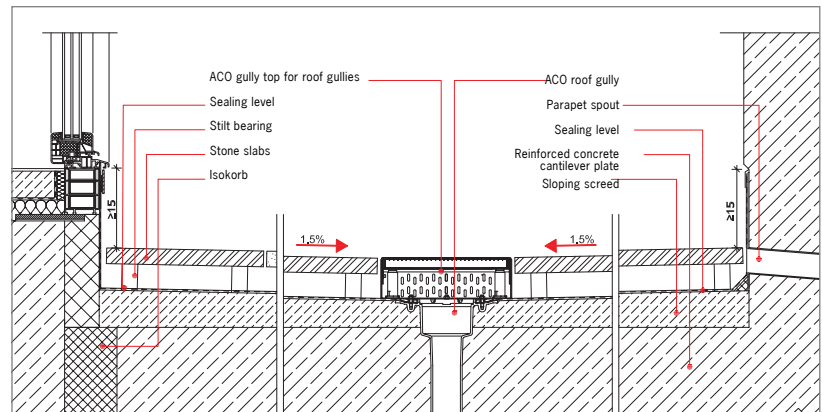

Max. 5 cm connection height of sealing rings on doors, glass fronts and similar to the surface of the coating with additional measures is possible.

- rules for roofs with sealing ring (Flat Roof Directive), Par. 4.4 (2) reduction of connection height on doors, fig. 6.2, 6.3 and 6.4 (As per: 12/2016)
- **NEW! Amendment of the Flat Roof Directive 12/2016: If the splash-water volume is not minimised by a roof, mesh gratings that are at least 150 mm wide should be used".**

Balcony with roof gully 'Sealing height' 5 cm – Roof edge with wall flange

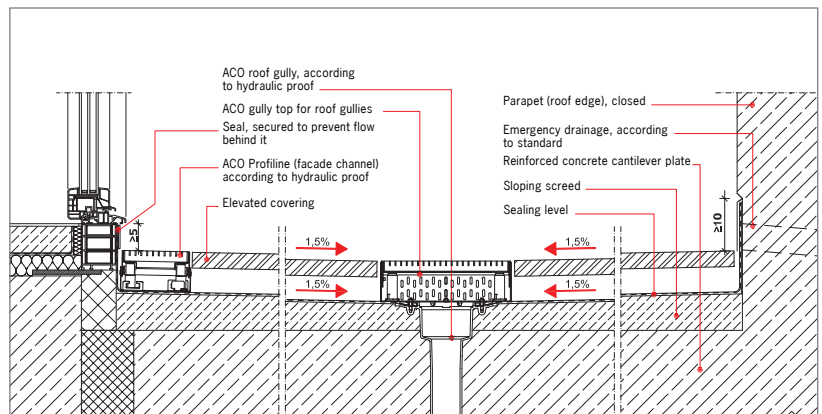

General information
Information about reducing the connecting height of sealing rings on doors, glass fronts and similar to 5cm above the surface of the coating.
The Flat Roof Directive and FLL guidelines present a clear solution for this connecting point. According to this, it is possible to reduce the connecting height to 5cm (upper edge coating/channel up to upper edge sealing ring), if flawless water drainage is ensured in front of the connecting area at all times. This cannot

usually be guaranteed by a roof gully because the distance from the roof gully to the ascending sealing ring needs to be at least 30 cm. For this reason, drainage channels that are perforated on both sides (drainage slots) are used here. The channel system should have a cover to match the local conditions And drain by means of the drainage slots above the sealing ring into the drainage layer.

The building height of the channel body may not be 10 cm. A decisive factor is that the water can drain at all times (hydraulic calculation)!



Barrier-free door sills (max. 2 cm) – same-level connection height of sealing rings on doors, glass fronts and similar to the surface of the coating with additional measures is possible.

- rules for roofs with sealing ring (Flat Roof Directive), Par. 4.4 (3) Barrier-free transition elements (As per: 12/2016)
- DIN 18040 Part 1 and 2, doors 4.3.3.1 General

**Balcony with roof gully
'Sealing height' 0 to 2 cm – Roof edge with wall flange**

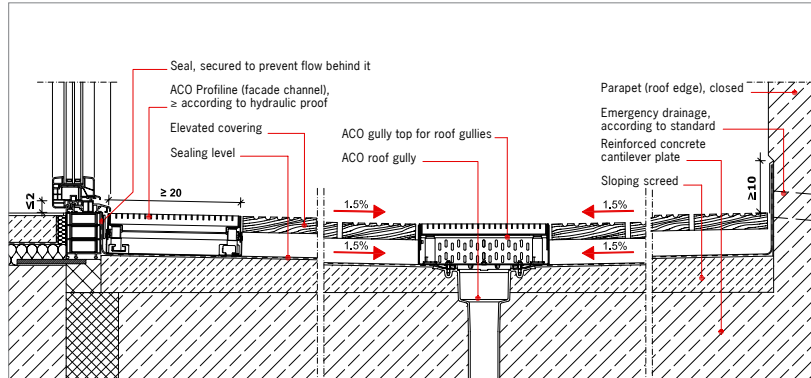

**Balcony with railing (closed roof edge)
Linear drainage – slope to railing**

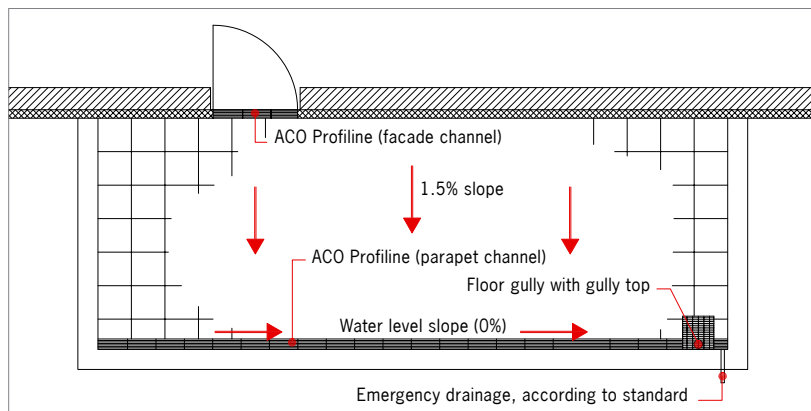

**Roof terrace with railing (closed roof edge)
Linear drainage - slope to middle**

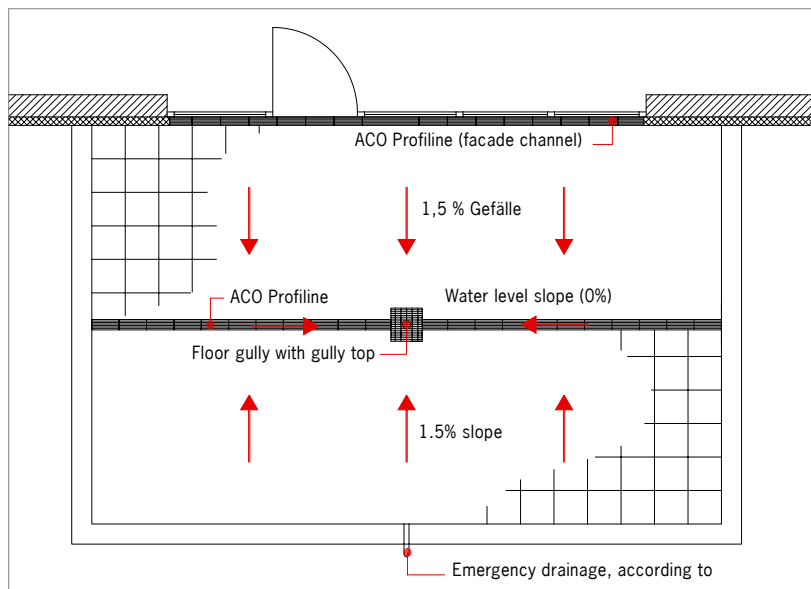

References

Rottendorf – sOliver

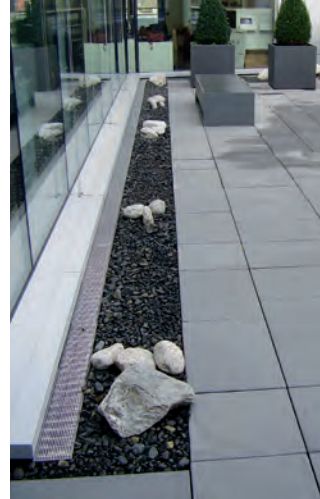

Solingen – Haribo

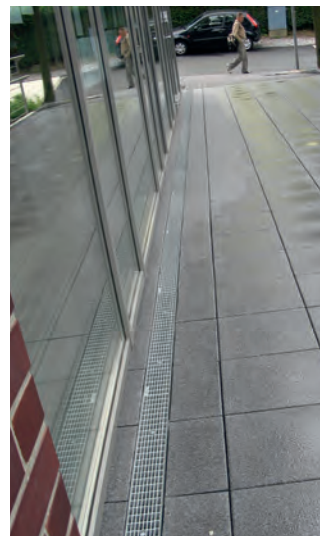

Köln – AXA

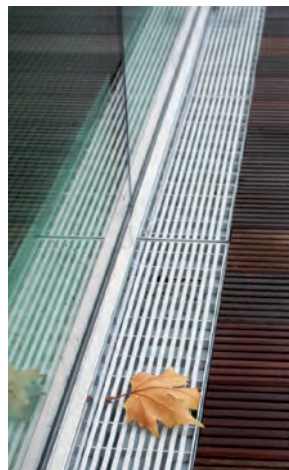

Hamburg – Ergo



Leipzig – Rosental terraces



Assembly instructions – ACO Profiline fixed building height

1. Connection of the channel elements

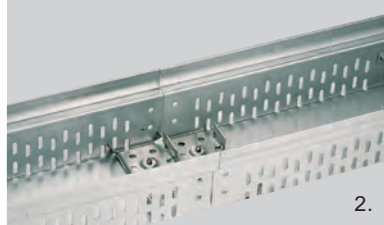
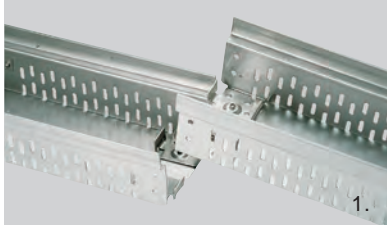

■ picture 1: The plug system for connecting the channels is designed so that a channel body lies flat and the following channel body is attached from top to bottom

■ picture 2: A firm connection between the channel bodies is created without screws or tools. The continuously closed channel base and the on-site protection layer guarantee that the sensitive rook skin below is not damaged

2. Attachment of end caps

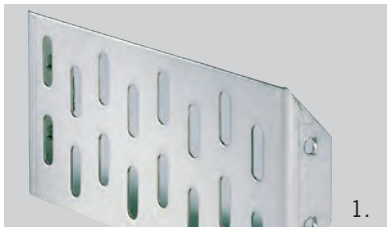

■ picture 1: The end cap must be mounted entirely screwless. It has two punched grooves for this on both sides

■ picture 2: The end cap must be mounted from inside to outside. Here, one side of the end cap with the punched recesses is placed into the designated boreholes. The other side is pressed outward until it clicks into the boreholes

■ picture 3: Completely mounted end cap

3. Grating lock



■ picture 1: All channel elements have channel lock prepared ex-works

■ picture 2: The grating lock is simply activated by turning it a quarter turn to the right or left using a slit screwdriver

4. Corner design

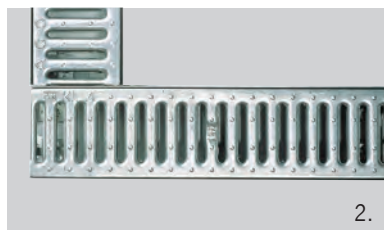

■ picture 1: End caps need to be used to create corners on both channel elements

■ picture 2: A clean corner is created by joining at a 90° angle. Stabilisation is achieved by processing the adjoining coating

Assembly instructions – ACO Profiline height-adjustable

1. Connection of the channel elements

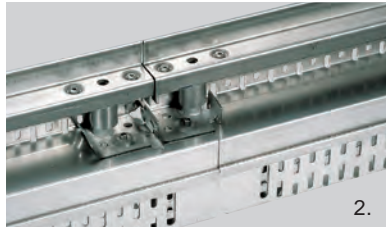
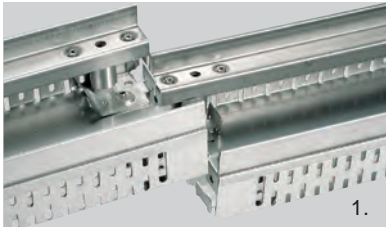

- picture 1: The plug system for connecting the channels is designed so that a channel body lies flat and the following channel body is attached from top to bottom
- picture 2: A firm connection between the channel bodies is created without screws and tools. The continuously closed channel base and the on-site protection layer guarantee that the sensitive rook skin below is not damaged

2. Attachment of end caps



- picture 1: The end cap adapts to the respective building height
- picture 2: The end cap and the marked slots are pushed into the recesses at the end of the channel

3. Assembly of the centre compensation element

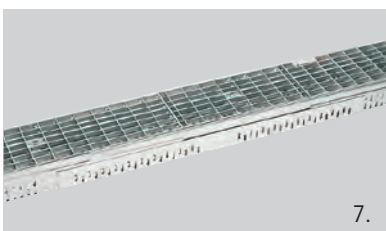
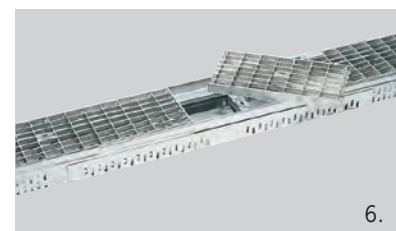
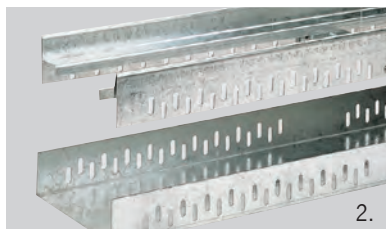

- picture 1: The centre compensation element also allows free length adjustment of 5 to 50 cm between at least two channel elements.
- picture 2: The soil and frame are completely separated when assembling the compensation element.
- picture 3: Place the two channel elements in the soil of the compensation element and create the required compensation length.
- picture 4: The frame of the compensation element is placed over the frame of the channel element
- picture 5–7: The cover grating length is adjusted and can also be locked in the compensation element.

4. Assembly of the end compensation element

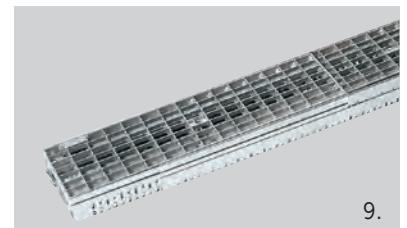
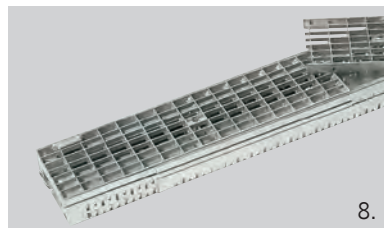
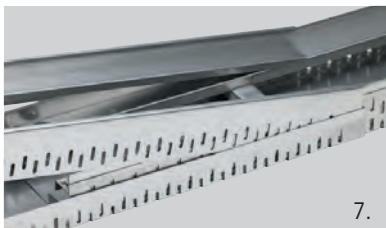
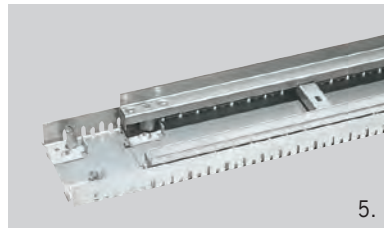
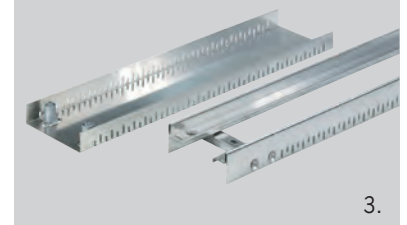
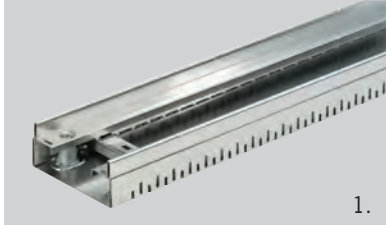

- picture 1: The end compensation element also allows free length adjustment of 10 to 5 cm behind or in front of a channel element.
- picture 2–3: The soil and frame are completely separated when assembling the compensation element.

- picture 4–5: Place the channel element in the soil of the compensation element and create the required compensation length.
- picture 6–7: The frame of the compensation element is placed over the frame of the channel element.

- picture 8–9: The cover grating length is adjusted and can also be locked in the compensation element.

5. The height adjustment



- picture 1–2: The height adjustment is located below the cover grating at both ends of the channel and can be easily reached at any time by moving the grating.
- picture 3: The building height can be freely adjusted using a slit screwdriver or a 5 mm inner hex wrench.

6. The grating stop

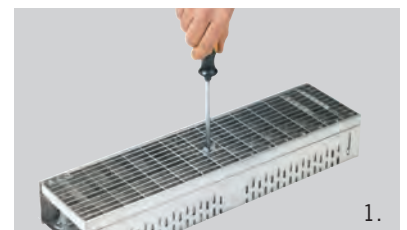

- picture 1: The grating lock is simply activated by turning it a quarter turn to the right or left using a slit screwdriver.

7. Corner creation with variable corner element 0–90° (does not fit on the compensation element)

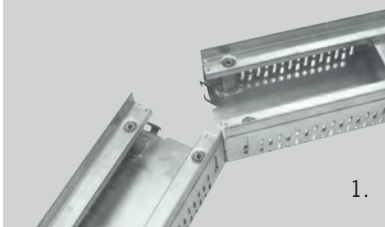

1.



2.

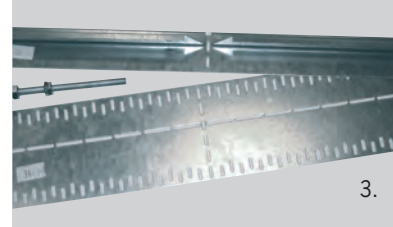

3.



4.



5.



6.

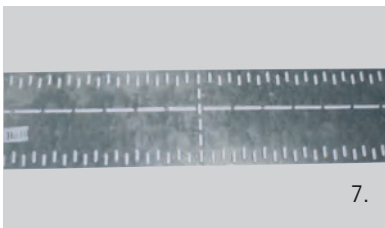

7.

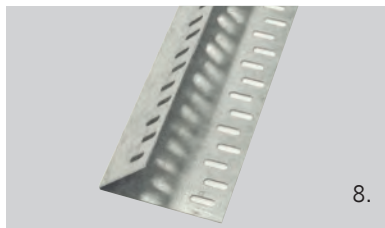

8.

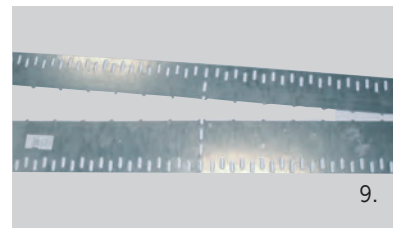

9.



10.



11.

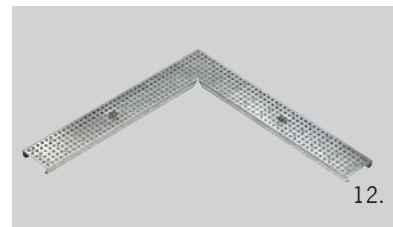

12.

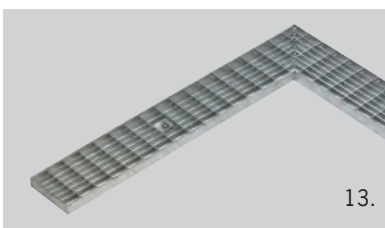

13.

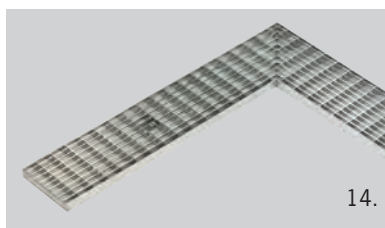

14.

- picture 1: The channel elements are positioned in the required angle.
- picture 2–3: The adhesive tape in the packaging can be easily removed without residues.
- picture 4: The variable corner element is adapted to the angle and placed over the frame of the channel element.

- picture 5–6: The threaded rod is affixed with nuts below the corner element and shortened to the required height.
- picture 7–8: Separation of the gravel ledge by bending the perforation over.
- picture 9: The gravel ledge (suitable for all building heights) is adapted to the building height of the channel element.
- picture 10–11: The gravel ledge is set at the right angle and then placed loosely on the channel element.
- picture 12–14: The cover gratings are locally cut to the required angle on site. At an angle of 90°, there are numerous prefabricated gratings available.

ACO Profiline with direct or indirect connection to the drainage

Branch channel elements – placement of the branch channel

The side wall is simply opened with wire cutters. A cut in the middle is enough;

both side parts are simply folded outward and serve to affix the branch channel.



Branch channel elements – placement of the branch channel

A branch channel lies in the drainage layer. It guarantees secure water flow to the gully. The branch channel connection elements fulfil the requirement for direct

and/or indirect connection to a drainage system. The elements are each 0.5 m long and can be inserted at the corresponding point in the channel train. The

other end of the branch channel ends on the gully top for roof gullies that also needs to be opened.

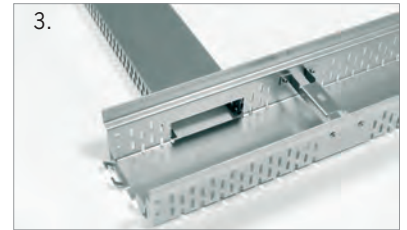
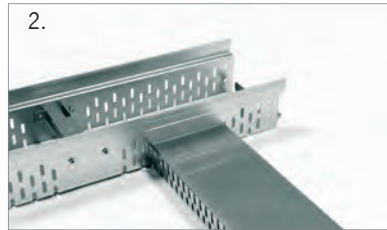
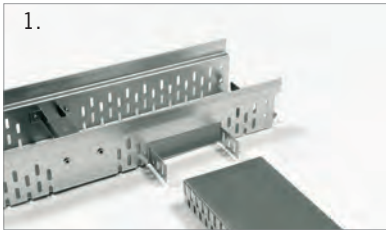

Branch channel connection on the gully top for roof gullies

The branch channel connection elements fulfil the requirement for direct and/or indirect connection to a drainage system. The side wall is simply opened with wire cutters. A cut in the middle is enough. Both side parts are simply folded outward and serve to affix the branch channel in position during processing.

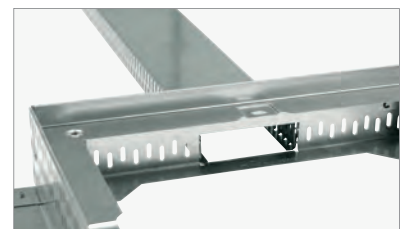
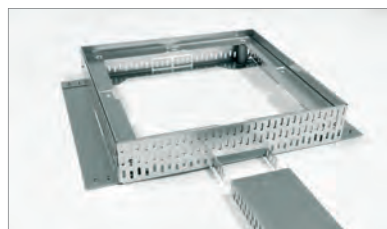

Maintenance and cleaning of the branch channels

Regular cleaning is necessary when the branch channel is connected directly, i.e. when the channel body and the gully top for roof gullies are opened. It is recommended installing a cleaning shaft approx. every 4 m; this can also be the gully top for the roof gullies. Actual rinsing can be carried out with a simple garden hose.

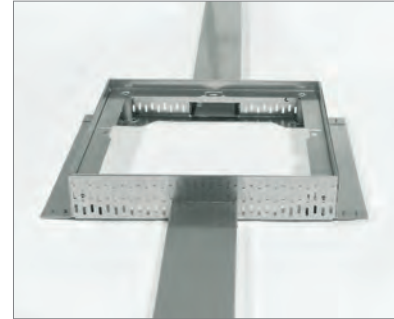
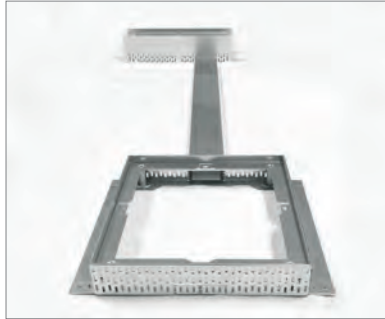

Gully top for roof gullies with locked mesh gratings



The two supplied clamps are pushed over two of the opposite grooves (depending on the position of the grating) with the flat side facing upwards.



After inserting the grating, the holding clamps are screwed to the gully top through the mesh using the supplied M5 screw. Locking device of the gully tops at a fixed building height and the extension elements functions in the same way.





Product data sheet

ACO Profiline, ACO Roofline, ACO Greenline 3.0

ACO façade and terrace channels serve to meet the requirements of the valid directives (DIN 18531, Flat Roof Directive, FLL) and prevent water penetration as a result of the wind load or collection in front of particularly endangered areas. The surface water and suspended substances are discharged via the lateral drainage slots into branch channels that lead to the gullies, in the free area below block pavements on raised floors/sacks of mortar and/or into the drainage layer. A branch channel is a hollow body with lateral drainage slots. Its front side is butt joined to the drainage slots of the channel body and the gully top for roof gullies, and lies within the drainage layer. Therefore, it connects the channel body and the gully top, and forms a defined drainage channel. The gully tops for roof gullies on terrace surfaces must be arranged across the roof gullies as inspection shafts.



ACO Profiline

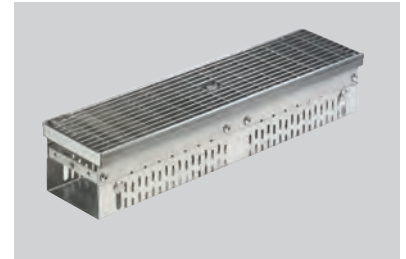

ACO Roofline



ACO Greenline 3.0

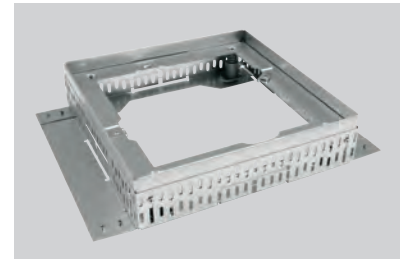

ACO gully tops for roof gullies

Field of application

- façades
- terraces
- balconies
- porches
- green roofs
- roof gardens
- barrier-free construction

Carrying capacity

- accessible on foot
- accessible for wheelchairs

Materials

- galvanised steel
- stainless steel 1.4301 (V2A)

Channel connections

- tongue-and-groove system (ACO Profiline)
- channel connector (ACO Roofline/ ACO Greenline 3.0)

grating stop

- stopping of the grating thanks to system that is pre-assembled at our works
- ACO Greenline 3.0 and gully tops without grating stop

Channel elements

- close channel base
- with integrated gravel ledge

Cleaning

- rinse with water
- with brush/broom
- with trowel

Slope

- without slope

Combination of materials

In principle, outdoor area combinations of stainless steel and non-noble materials (e.g. stainless steel channels and cast or galvanised gratings) should be avoided due to the high risk of contact corrosion. When elements are formed, the non-noble material can corrode much more quickly. In addition, the passivity of the stainless steel can become lost, in particular if reducing corroding agents are also added (e.g. de-icing salt).

Corrosion by foreign atoms

Natural cleaning by means of surface water is significantly reduced primarily in covered areas. This means that foreign atoms that are deposited from the environment (e.g. from brake disks, dust, sand etc.) are not removed by the surface water.

These foreign atoms can cause corrosion. This is not substantial rust of the stainless steel material, instead less noble foreign atoms from the environment dissolve on the surface. Regular maintenance

and cleaning intervals contribute to significantly reducing extraneous rust corrosion.

General information

Installation in a gravel bed

The ACO Roofline is installed in a gravel bed depending on the on-site circumstances, but is generally no problem thanks to the closed channel base.

Cutting the channel body

It is not recommended cutting the channel body to adjust the length because this means that the overall system loses its functionality near the height adjustment.

The ACO Profiline program offers the functional alternative of the compensation element here.

Further treatment of interfaces in the stainless steel area

The interfaces of cut stainless steel parts must be retreated.

Corrosion is prevented when the interfaces are brushes or etched.

Further treatment of interfaces in the galvanised area according to EN ISO 1461 Paragraph 6.3 reworking

The sum of the areas without a coating that need to be reworked may not exceed 0.5 % of the total surface of the single component. A single area without a coating may not exceed 10 cm².

The reworking must involve thermal spraying with zinc or a suitable zinc duct coat within the practical limits of these systems.

It is also possible to use zinc-based solders. The contractor or end user must be informed about the applied reworking procedure.

The reworking must also include the removal of impurities and necessary cleaning and surface preparation of the damaged areas to ensure adhesion.

ACO Building Material's service range for the planner

Please contact the application technology team at ACO Building Material free-of-charge if you have any detail questions, if you require an exact hydraulic calculation, parts lists, article descriptions, installation plans or personal support at the construction site.

ACO Building Material in the internet

Information about our products, public tender texts (in the formats GAEB, HTML, TEXT, PDF, XML, DOC and ÖNORM), technical drawings (in the formats DXF and PDF) and installation manuals are available online in the service section at:

www.aco-hochbau.de

Direct access to the component:

www.fassadenrinne.de

ACO Hochbau Vertrieb GmbH

Am Ahlmannkai
24782 Büdelsdorf



ACO. creating
the future of drainage

Each ACO Building Material product supports the ACO system chain

System solutions for the cellar

- Basement window
- Assembly panels for light shafts
- Pressurised watertight light shafts
- Backflow systems

Infrastructure for house and garden

- Bath drainage
- Manhole covers
- Façade channels
- Linear drainage
- Point drainage
- Shoe scrapers
- Honeycomb mesh grass paver and gravel stabilisation
- Infiltration trench

Barn windows and escape doors

ACO Hochbau Vertrieb GmbH

Postfach 11 25
97661 Bad Kissingen
Neuwirtshäuser Straße 14
97723 Oberthulba/Reith
Tel. 09736 41-60
Fax 09736 41-52

hochbau@aco.com
www.aco-hochbau.de
www.fassadenrinne.de