

Installation manual

ACO Access Covers

SERVOKAT GD FR

- |            |  |            |  |
|------------|--|------------|--|
| <b>ENG</b> | <b>Installation Manual<br/>ACO Access Cover</b>          | <b>EST</b> | <b>Paigaldusjuhend</b>                                     |
| <b>GER</b> | <b>Installationsanleitung<br/>ACO Schachtabdeckungen</b> | <b>LAV</b> | <b>Uzstādīšanas instrukcija<br/>ACO Tehnisko lūku vāki</b> |
| <b>FRA</b> | <b>Instructions d´installation</b>                       | <b>LIT</b> | <b>Montavimo instrukcija<br/>ACO apžiūros liukai</b>       |
| <b>ESP</b> | <b>Manual De Instalación<br/>ACO Tapas de registro</b>   | <b>POL</b> | <b>Instrukcja montażu</b>                                  |
| <b>POR</b> | <b>Manual de Instalação</b>                              | <b>BUL</b> | <b>Инструкции за инсталация</b>                            |
| <b>ITA</b> | <b>Manuale d´installazione<br/>ACO Access Cover</b>      | <b>HUN</b> | <b>Beépítési útmutató</b>                                  |
| <b>NLD</b> | <b>Installatiehandleiding<br/>ACO Toegangsluiken</b>     | <b>RUM</b> | <b>Instructiuni de instalare</b>                           |
| <b>CZE</b> | <b>Instalační manuál</b>                                 | <b>HRV</b> | <b>Upute za ugradnju</b>                                   |
| <b>RUS</b> | <b>Инструкция По Установке</b>                           | <b>SLV</b> | <b>Navodila za vgradnjo</b>                                |
| <b>SWE</b> | <b>Installationsanvisning</b>                            | <b>SRP</b> | <b>Preporuka za ugradnju</b>                               |
| <b>NOR</b> | <b>Installasjons Manual</b>                              | <b>TUR</b> | <b>ACO Müdahale Kapakları</b>                              |
| <b>FIN</b> | <b>Asennusohje</b>                                       |            |  |
| <b>DAN</b> | <b>Installationsvejledning</b>                           |            |  |

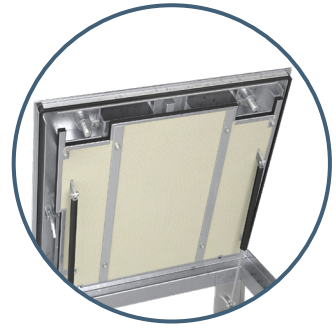

## ACO Access Covers SERVOKAT GD FR

### Load class B 125

#### Order information – Galvanised steel

| Clear opening<br>(A x B) | External dimensions<br>(C x D) | Frame height | Load class<br>(EN 124) | Weight | E    | EI   | Lock type | Lock type         |
|--------------------------|--------------------------------|--------------|------------------------|--------|------|------|-----------|-------------------|
|                          |                                |              |                        |        |      |      | NORMAL    | EMERGENCY<br>EXIT |
| [mm]                     | [mm]                           | [mm]         |                        | [kg]   |      |      | Part No.  | Part No.          |
| 600x800                  | 744x944                        | 130          | B125                   | 132,2  | E120 | EI60 | 448168    | –                 |
| 600x800                  | 744x944                        | 130          | B125                   | 138,3  | E120 | EI60 | –         | 448171            |
| 800x800                  | 944x944                        | 130          | B125                   | 160,6  | E120 | EI60 | 448158    | –                 |
| 800x800                  | 944x944                        | 130          | B125                   | 166,7  | E120 | EI60 | –         | 448162            |
| 800x1000                 | 944x1144                       | 130          | B125                   | 181,9  | E120 | EI60 | 448167    | –                 |
| 800x1000                 | 944x1144                       | 130          | B125                   | 188    | E120 | EI60 | –         | 448173            |
| 1000x1000                | 1144x1144                      | 130          | B125                   | 217,2  | E120 | EI60 | 448159    | –                 |
| 1000x1000                | 1144x1144                      | 130          | B125                   | 223,3  | E120 | EI60 | –         | 448169            |

### Load class D 400

#### Order information – Galvanised steel

| Clear opening<br>(A x B) | External dimensions<br>(C x D) | Frame height | Load class<br>(EN 124) | Weight | E    | EI   | Lock type | Lock type         |
|--------------------------|--------------------------------|--------------|------------------------|--------|------|------|-----------|-------------------|
|                          |                                |              |                        |        |      |      | NORMAL    | EMERGENCY<br>EXIT |
| [mm]                     | [mm]                           | [mm]         |                        | [kg]   |      |      | Part No.  | Part No.          |
| 600x800                  | 744x944                        | 130          | D400                   | 141,8  | E120 | EI60 | 448190    | –                 |
| 600x800                  | 744x944                        | 130          | D400                   | 147,9  | E120 | EI60 | –         | 448195            |
| 800x800                  | 944x944                        | 130          | D400                   | 172    | E120 | EI60 | 448179    | –                 |
| 800x800                  | 944x944                        | 130          | D400                   | 178,2  | E120 | EI60 | –         | 448184            |
| 800x1000                 | 944x1144                       | 130          | D400                   | 196,7  | E120 | EI60 | 448192    | –                 |
| 800x1000                 | 944x1144                       | 130          | D400                   | 202,8  | E120 | EI60 | –         | 448188            |
| 1000x1000                | 1144x1144                      | 130          | D400                   | 235,9  | E120 | EI60 | 448180    | –                 |
| 1000x1000                | 1144x1144                      | 130          | D400                   | 242    | E120 | EI60 | –         | 448182            |

## Notes:

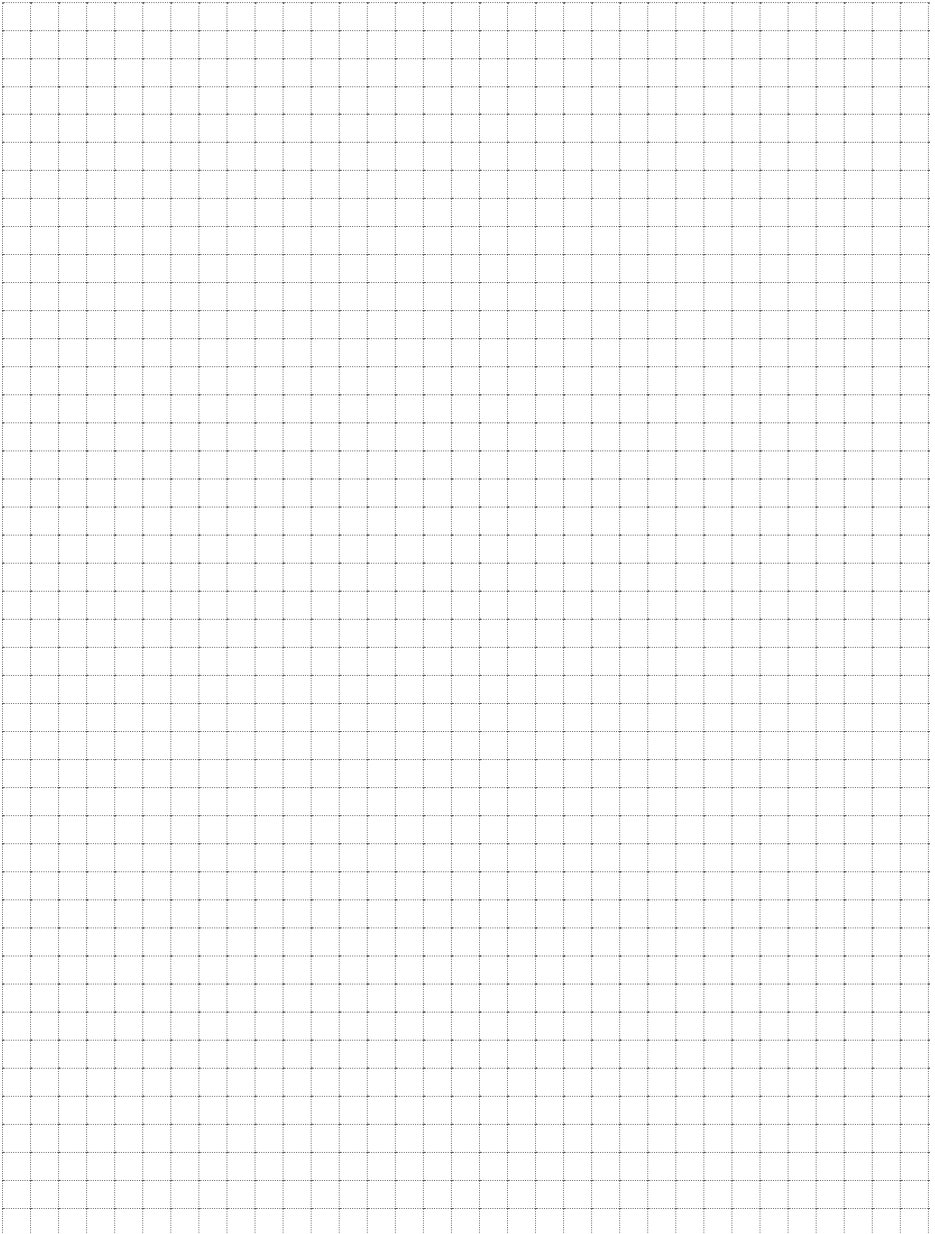
A large grid of small squares, intended for taking notes. The grid consists of 20 columns and 30 rows of small squares, forming a large rectangular area for writing.

Installation manual  
ACO Access Cover SERVOKAT GD FR

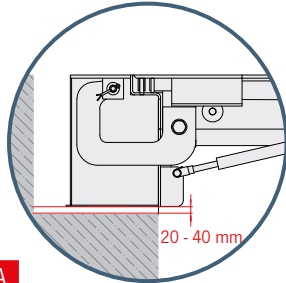
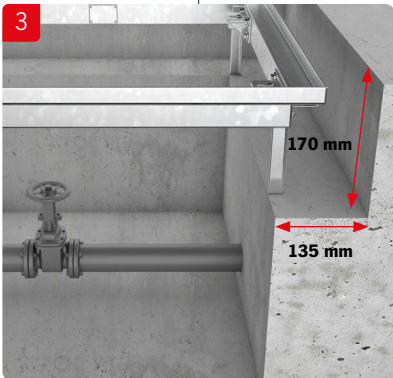
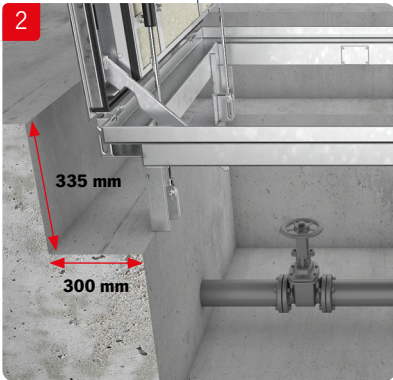
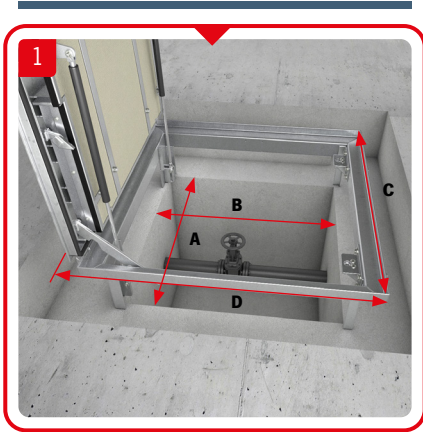

A

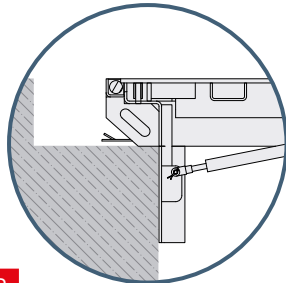
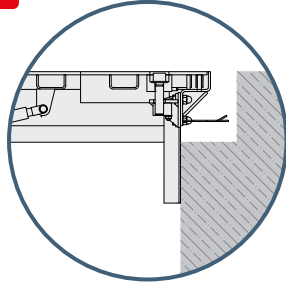

B

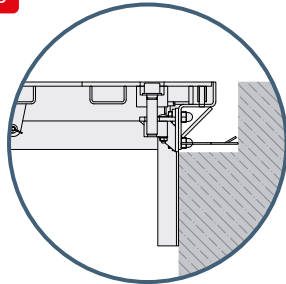

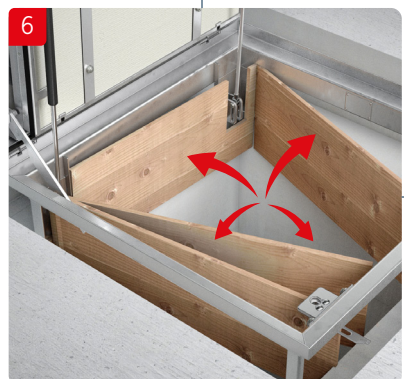
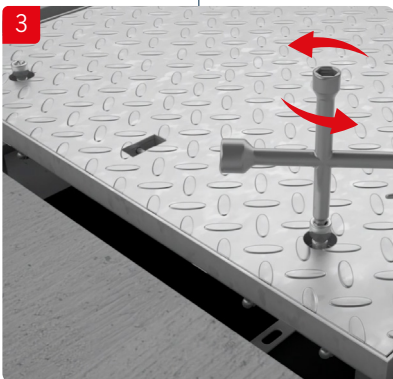
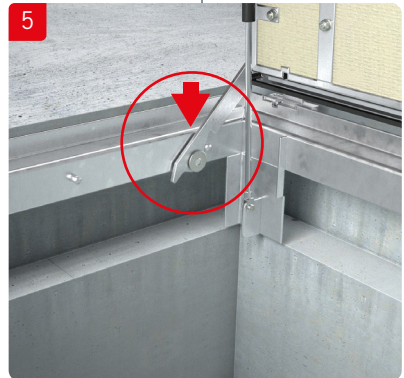
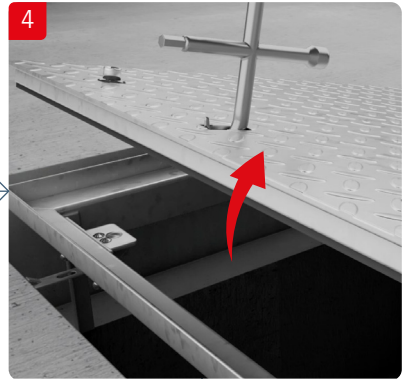



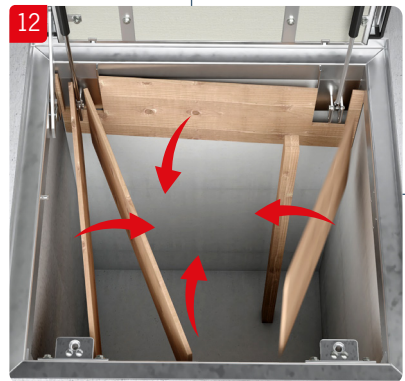
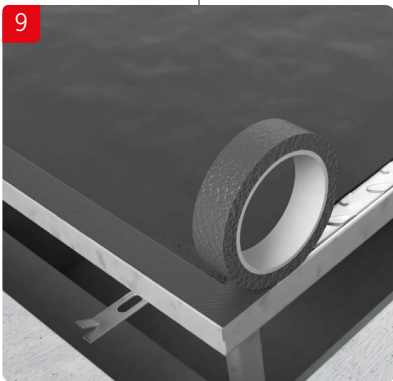
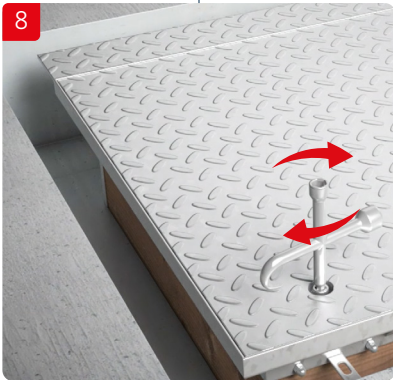
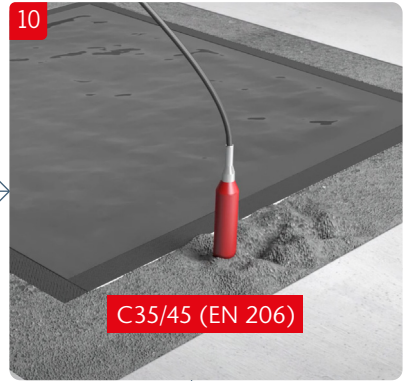
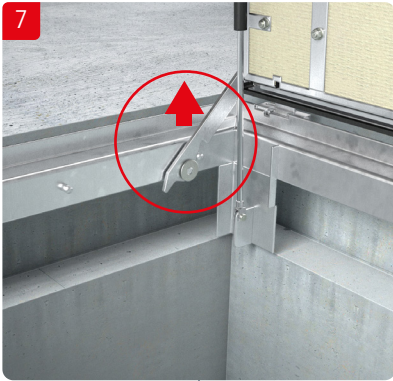



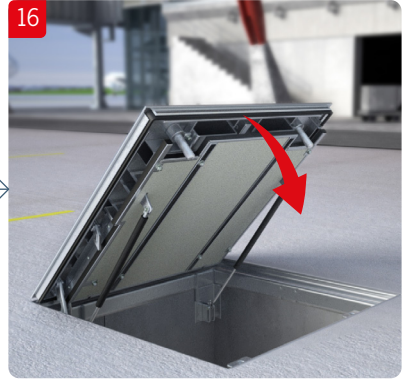

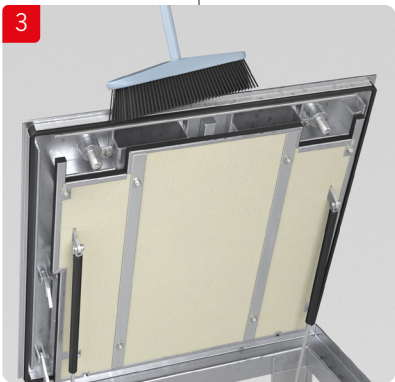
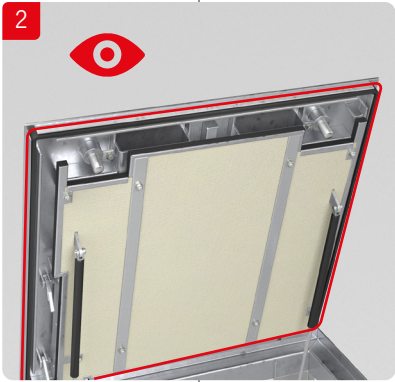
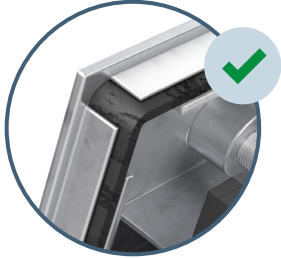
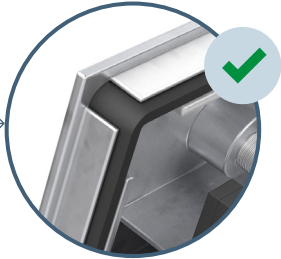

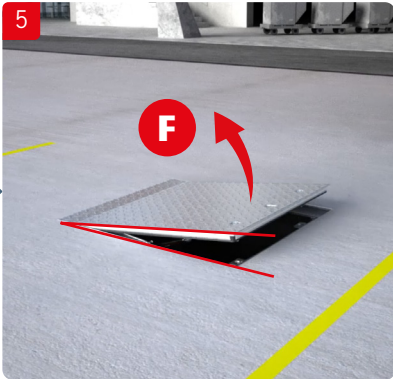

**$F \leq 25 \text{ kg}$**  ✓  
 **$F > 25 \text{ kg}$**  ✗

ACO. we care for water



Every ACO product supports  
the ACO WaterCycle



- 
- ACO Access Covers UNIFACE  
Fire Resistance (FR)
  - ACO Access Covers PAVING  
Fire Resistance (FR)
  - ACO Access Covers SOLID  
Fire Resistance (FR)
  - ACO Access Covers SERVOKAT GD  
Fire Resistance (FR)
- 



ACO Industries k.s.

Havlickova 260  
582 22 Pribyslav  
Czech Republic

[www.aco-accesscovers.com](http://www.aco-accesscovers.com)

NM19729 ACO Access Covers SERVOKAT GD FR Manual/EN/Q4/23